

Sustainable Approach for Building Cooling

Yi Jiang

Building Energy Research Center, Tsinghua University

2020/09/28

Climate change push increasing cooling demand

- Global warming lead to increasing cooling demand: 1°C increase in global average temperature will lead to an average increase in CDDs of 25%
- Climate change is increase global mean temp. as well as temp. variation, and increase in hot and record-hot weather is disproportionately worse in developing countries

Increase in CDDs in the Baseline Scenario relative to historical CDDs, 2016-2050

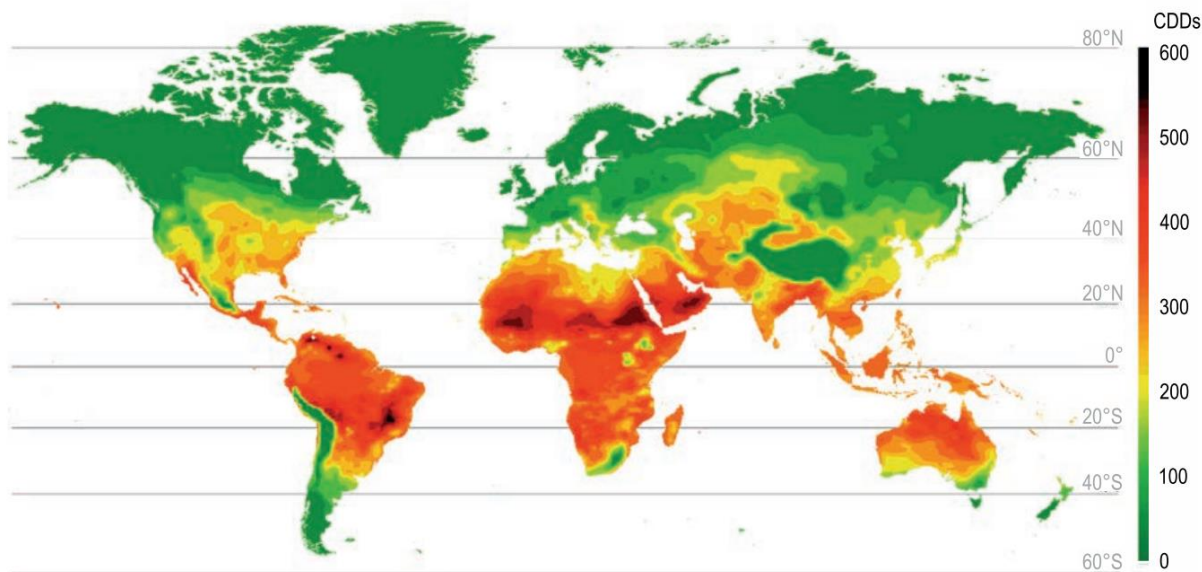

Source: IEA, *The future of Cooling*, 2018.

The effect on extreme temperatures when both the mean and variance increase for a normal distribution of temperature

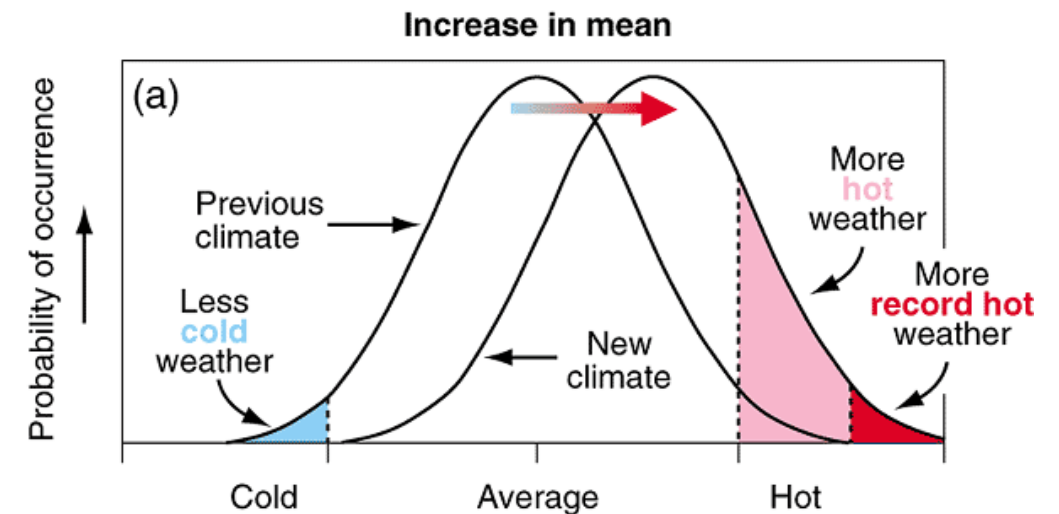

Source: IPCC Third Assessment Report: *Climate Change 2001. Working Group I: The Scientific Basis*

Urbanization process lead to emerging cooling demand

- Urbanization in emerging economy like China, India and ASEAN countries accelerates emerging cooling demand

Share of the total population living in urban areas, 1960
Proportion of the total population who live in urban areas.

Our World
in Data

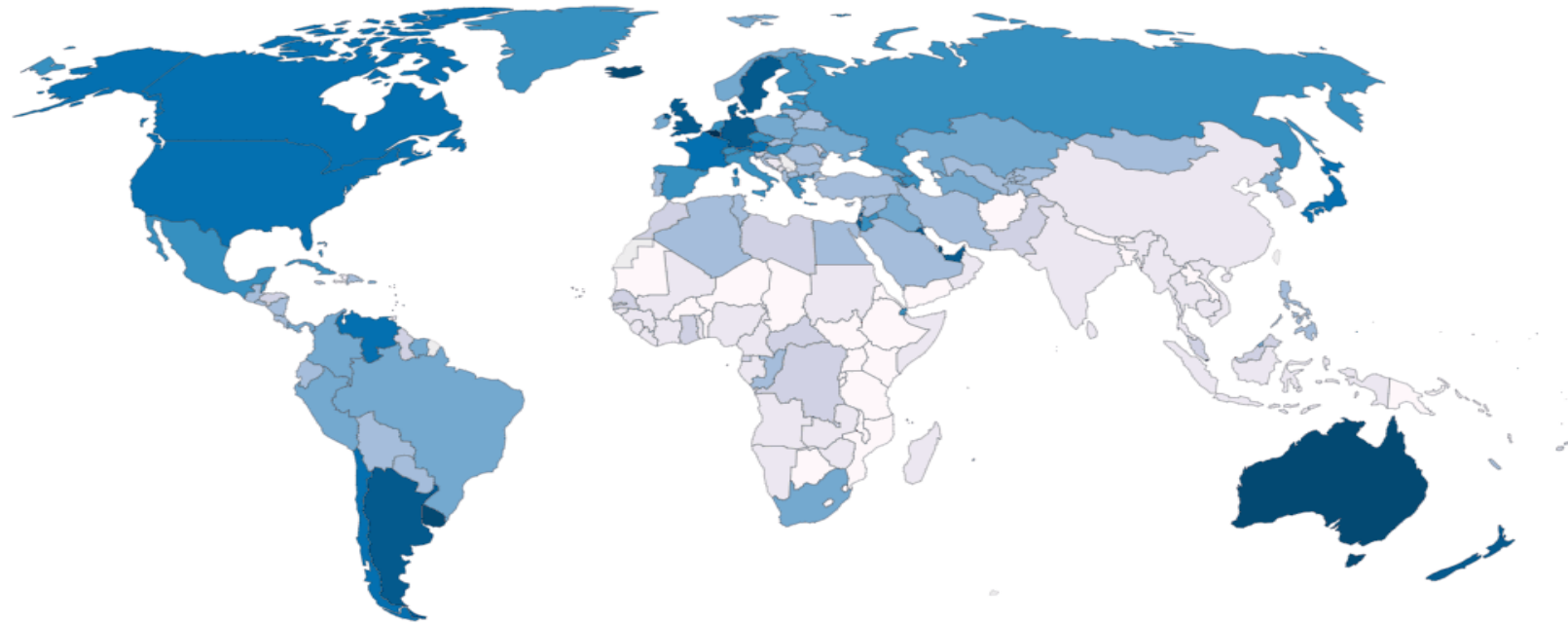

No data 0% 10% 20% 30% 40% 50% 60% 70% 80% 90% 100%

The demand of cooling in population

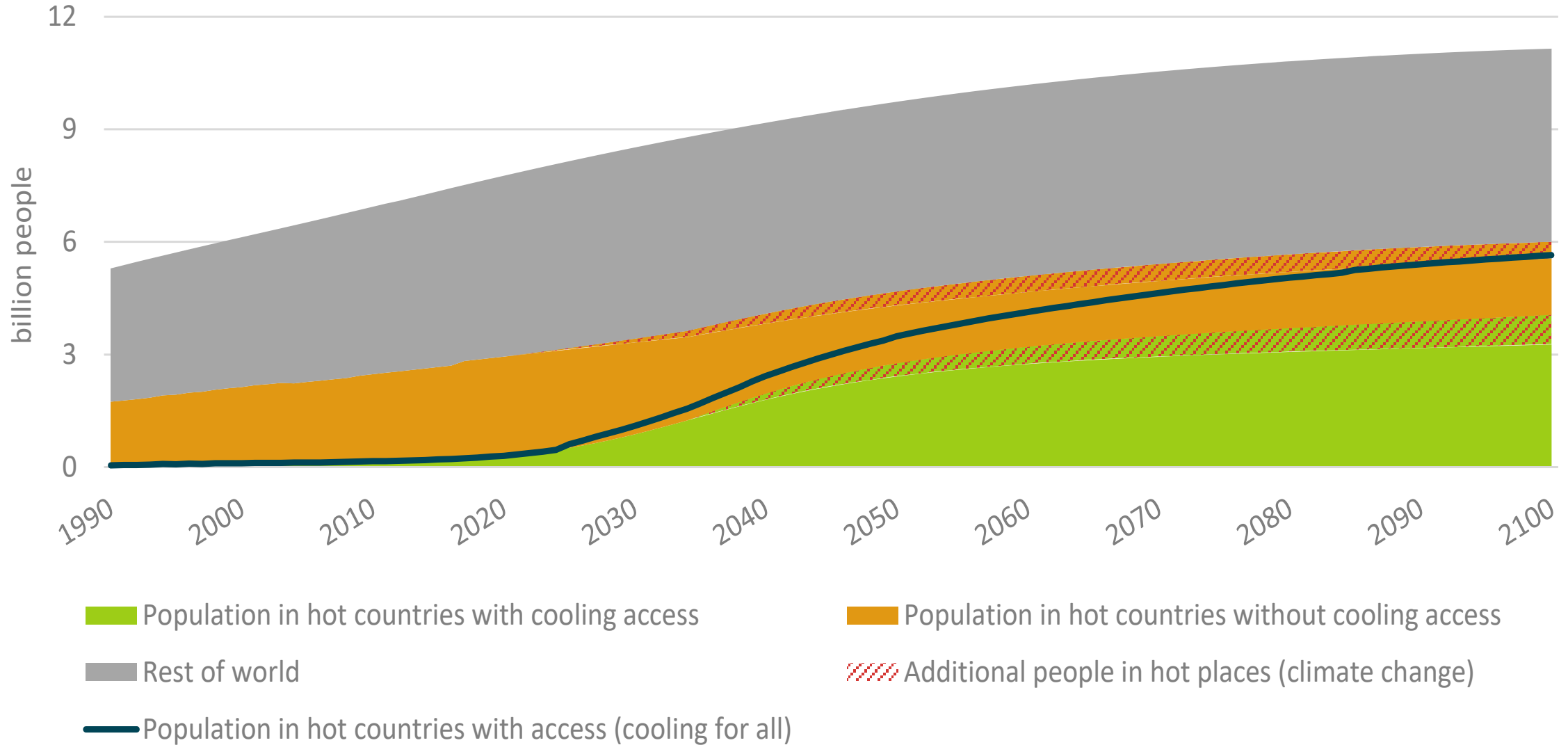

Cooling is a significant energy consumer and GHG emitter

- The IEA projects that global air conditioning energy demand will grow from **2020 TWh** in **2016** to **6200 TWh** in **2050**, with most of the growth in developing economies.
- Worldwide energy demand for space cooling will **overtake space heating by 2060**, and outstrip it by **60%** at the end of the century, as cooling demand in the developing countries of the global south grows faster than heating demand in the developed northern economies.
- The worldwide refrigerated vehicle fleet could grow from around **4 million** today to as much as **18 million** by 2025 to satisfy currently unmet demand in developing countries.

Figure 3.5 • World energy use for space cooling by subsector in the Baseline Scenario

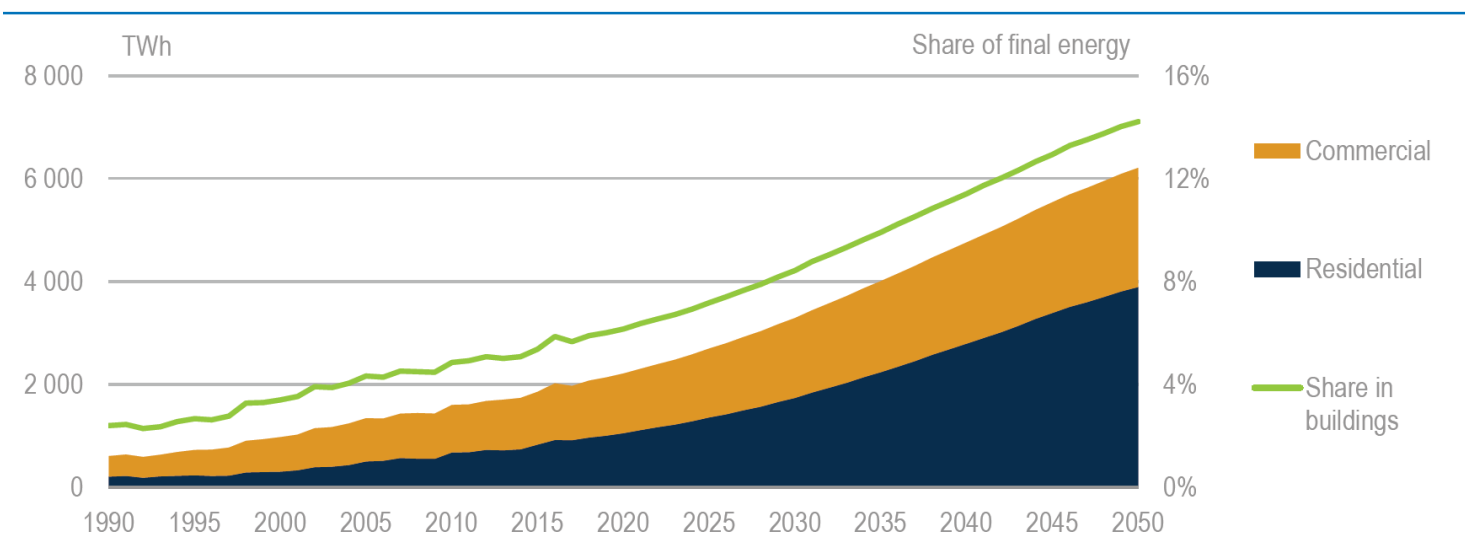

GHG emission caused by cooling

- HFCs GHG emissions is **1Gt CO2 equivalent** in 2015: **0.65Gt** by building cooling, **0.15Gt** by vehicle and cold chain, **0.2Gt** by other. This amount could be slightly overestimated due to rapid growth of cooling market.
- CO2 emission by cooling energy use of buildings in 2016 is around **1.2 Gt (2000 TWh, 2万亿kWh)**
- **Indirect** emission(CO2 fossil fuel): **Direct** emission(HFCs) = **2:1 ~8 :1**, due to great diversity of cooling energy usage, the energy structure, refrigerant GWP, refrigerant life time and leakage rate

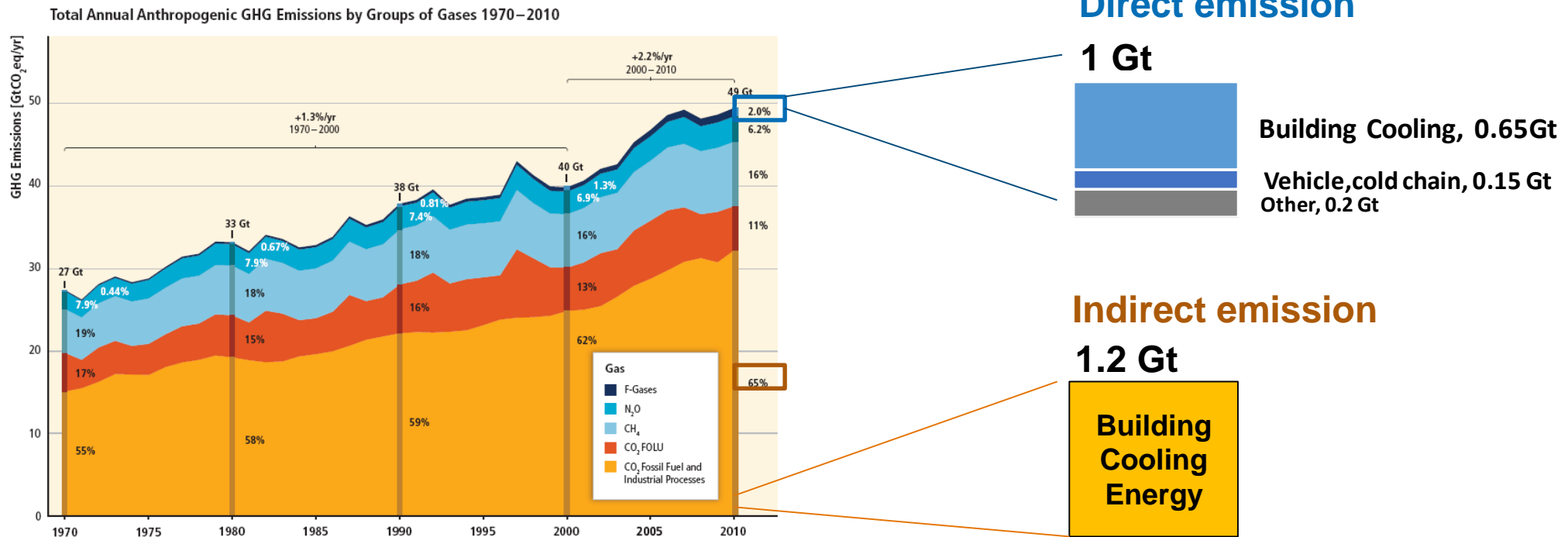

The technical approaches for reduce cooling

- **Reduce cooling demand while meeting thermal comfort and improving living standards**
- **Increase cooling energy efficiency, and decrease refrigerant leakage**
- **Utilization of renewable energy and NO GWP cooling technology**

Key features of cooling in civil building – part time part space

- In residential buildings, different behavior modes can lead to more than 10 times' difference

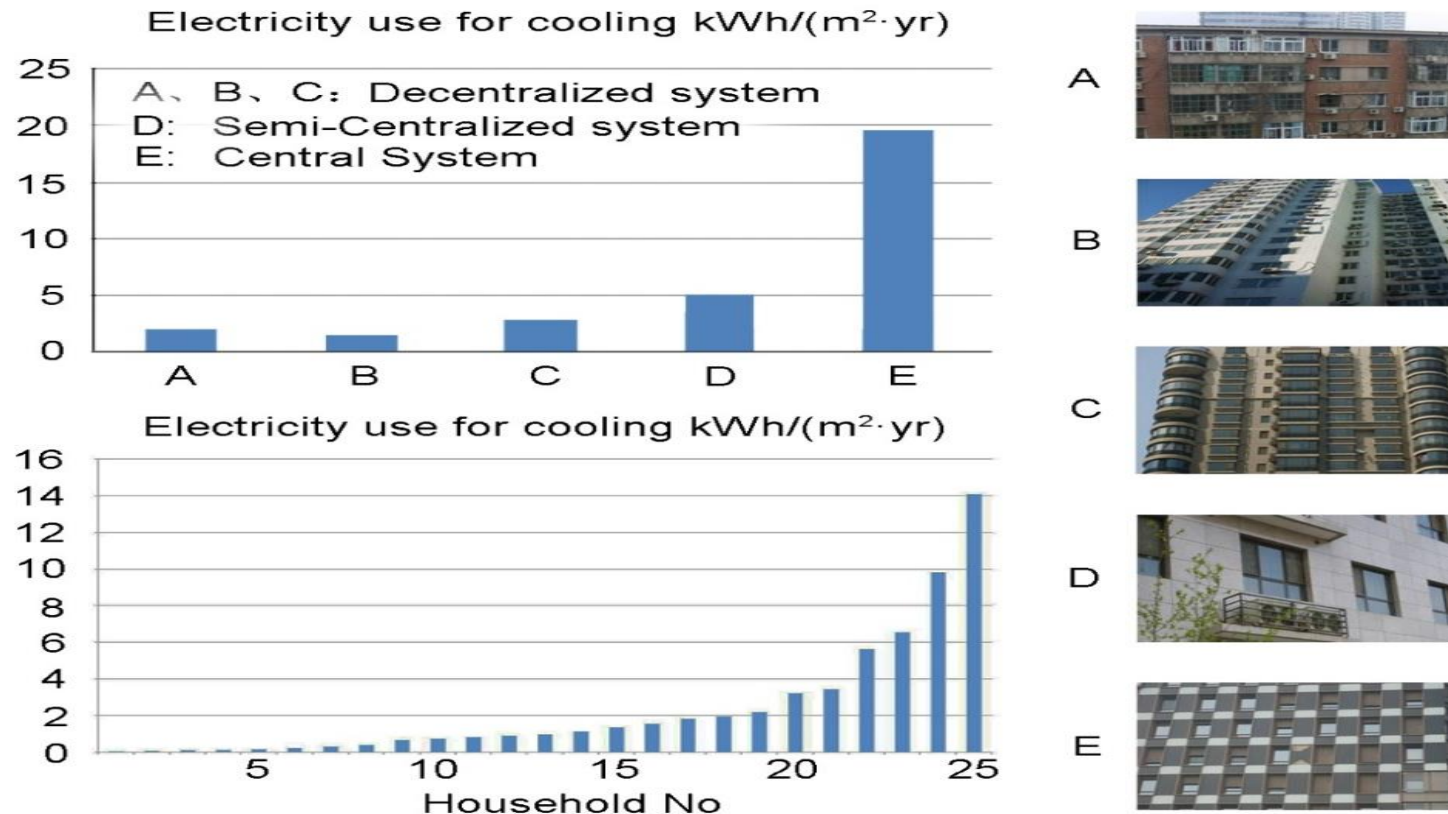

Field measurement of annual household electricity use of split-unit air conditioners in an apartment resident, Beijing, China, 2006

Measured cooling use in Beijing

Residential buildings in China

- China residential buildings

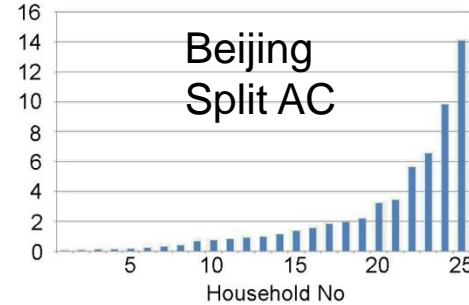
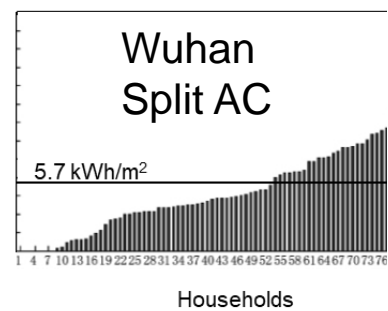
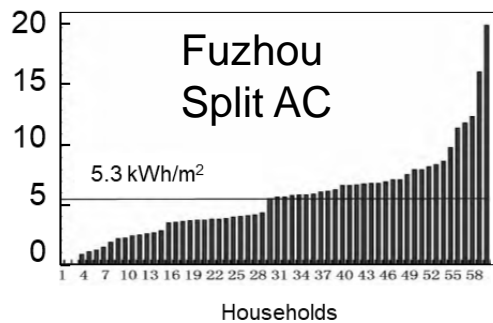
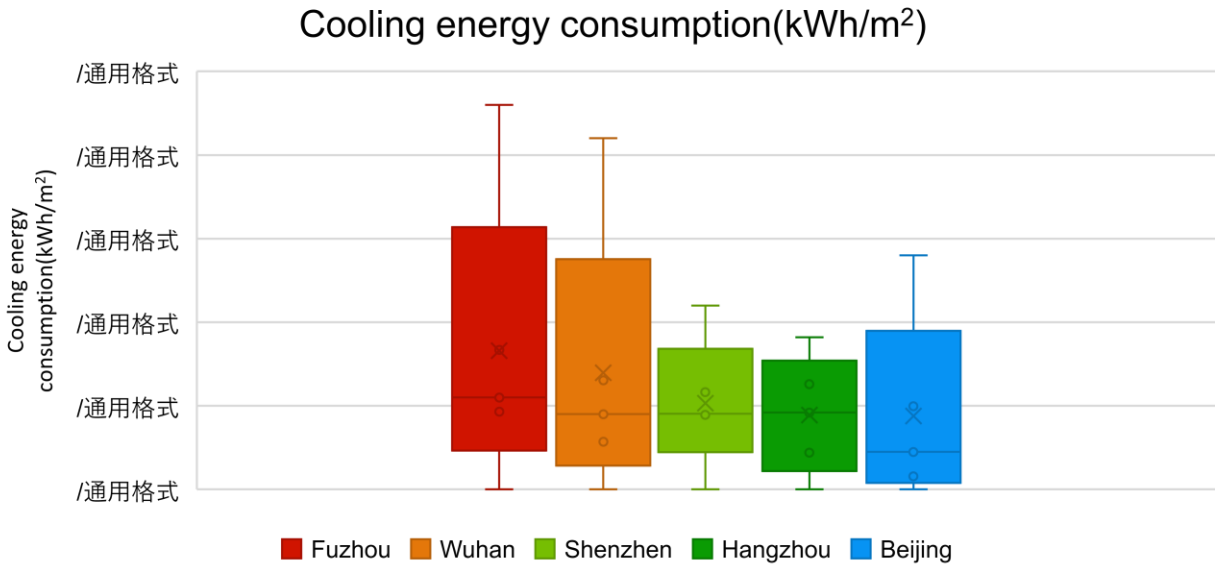

- ❖ Part time and Part space using pattern result in low cooling energy intensity

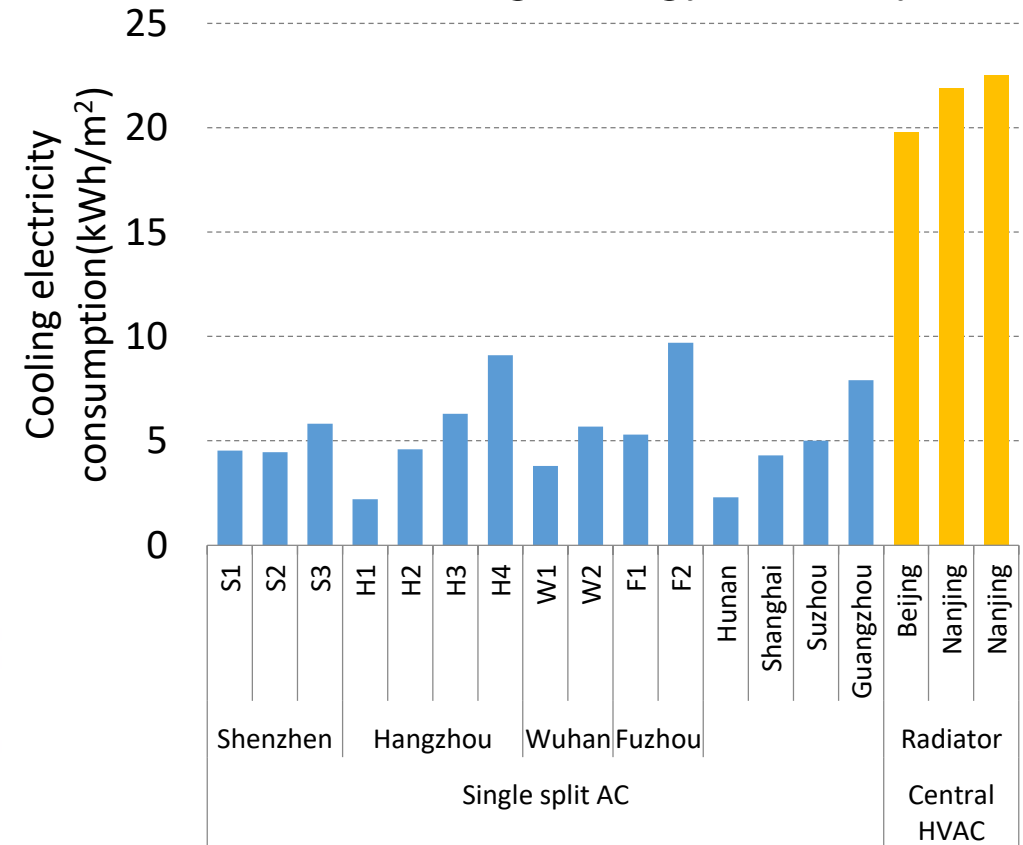

Key features of cooling in civil building – part time part space

Realities for residential VRFs in China:

- **Running quantity:** only one indoor unit running during 60% operating hours.
- **Operating Load:** load lower than 30% during 60% operating hours.
- Common habit for most Chinese users: minimize family living expense.

Indoor Unit Quantity Operating at the Same Time (Nationwide)

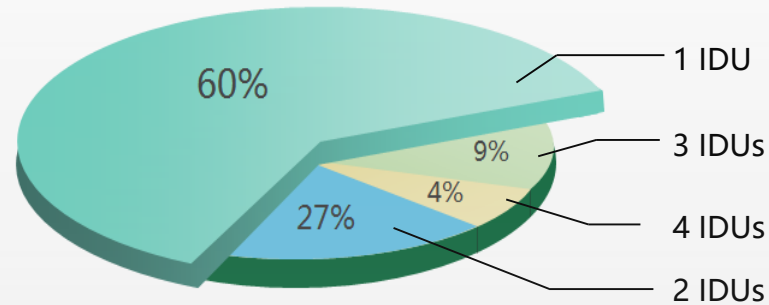

Operating Hours at Different Cooling Loads (Nationwide)

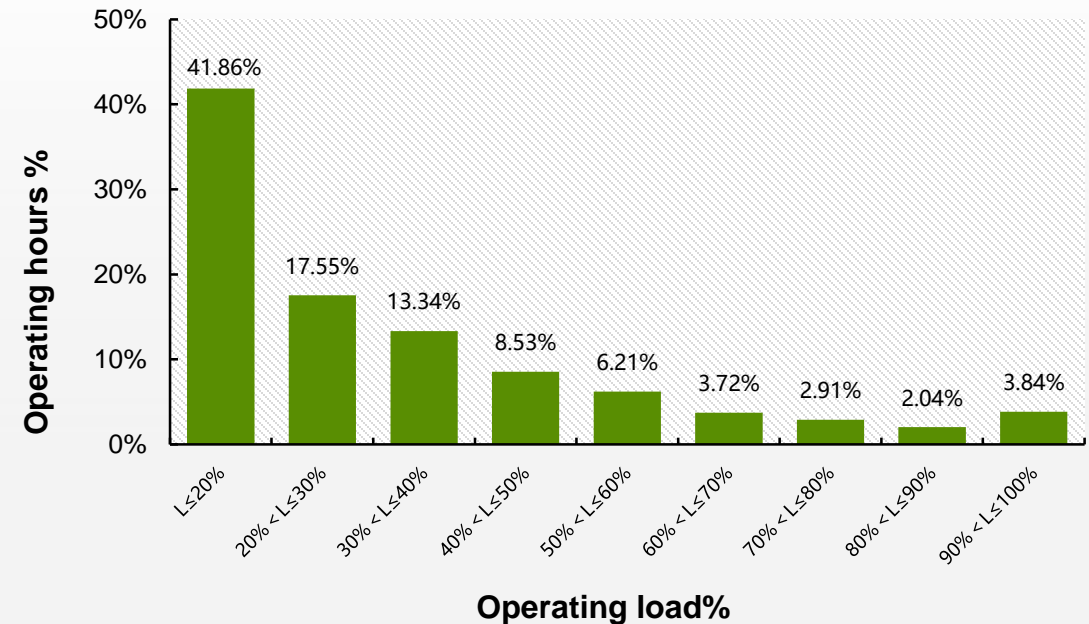

Data source: based on on-line data of **200,000** VRF samples

Key features of cooling in civil building – partial load operation

- When only one indoor unit is operating at 50% load, 1HP mono-split: load 50%, **EER 3.95**, 5HP VRF: load 10%, **EER 1.85**. It is why the consumption for VRF is higher than split.
- Minimum load of the traditional VRFs is 10% only, compressors frequently start and stop.

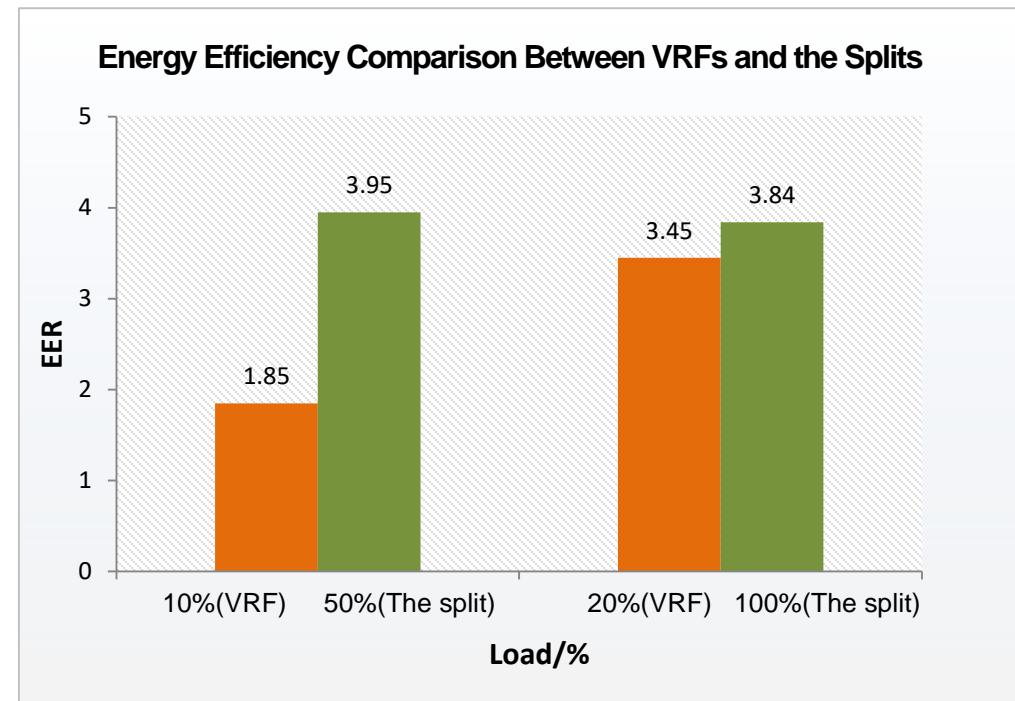
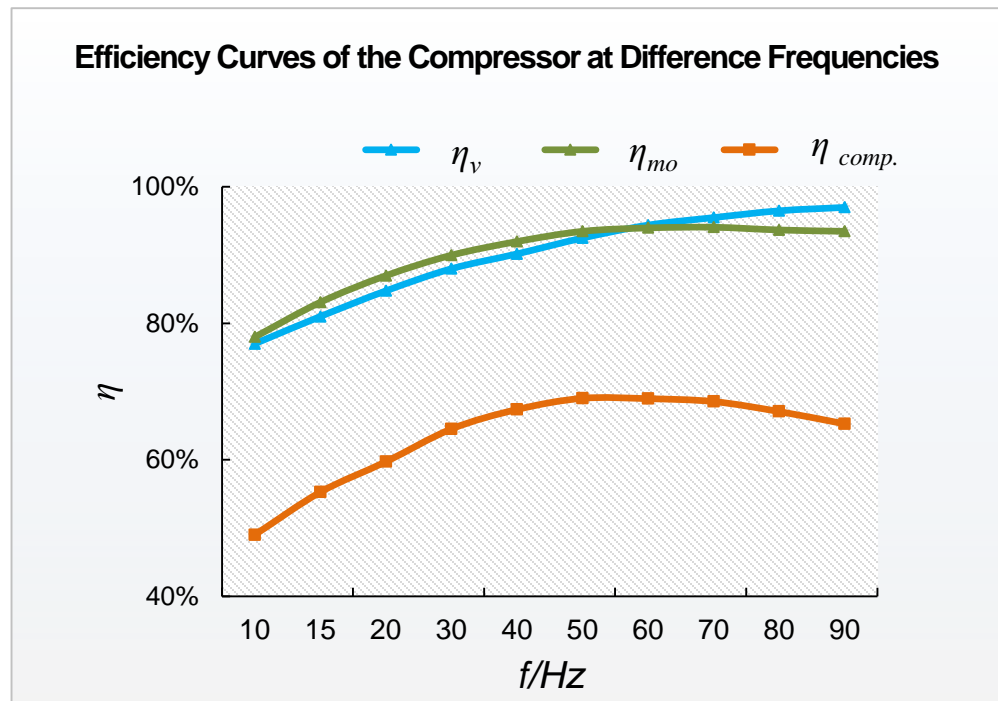

Data source: based on operation data of **200,000** VRF samples

Cooling system for office buildings in China

- China office buildings
- Three typical cooling modes: FCU only, FCU+OA, VAV

FCU only

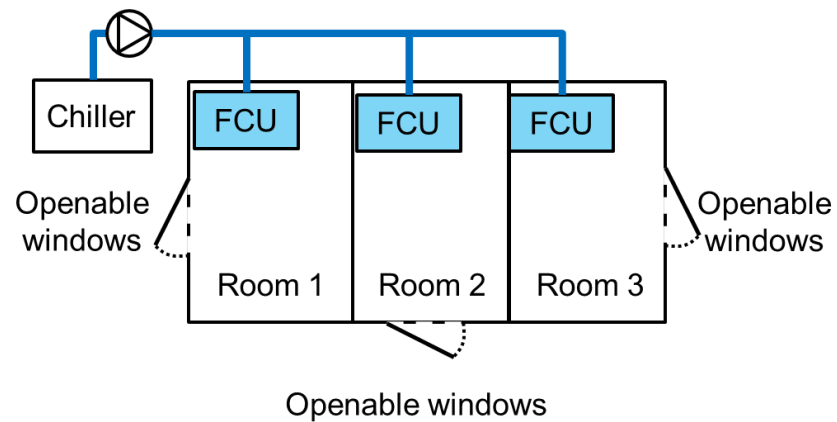

Energy consumption: 8.6kWh/m²

FCU+OA

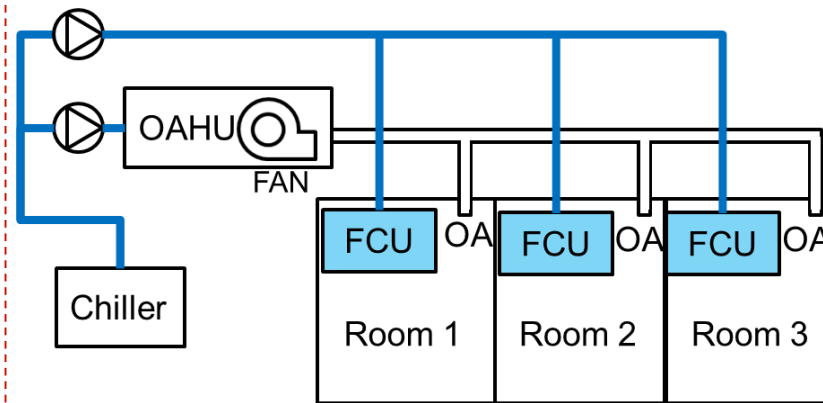

Energy consumption: 43.7kWh/m²

VAV

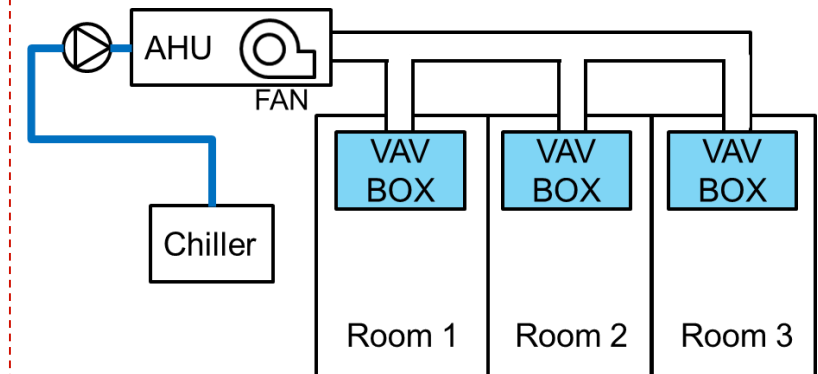

Energy consumption: 41.6kWh/m²

Office building: Central or decentral system

- Decentral system:
 - Split unit: < 10 kWh/m² in most offices in China
- Semi-decentral system: (less than 12 hours operation)
 - FCU (open windows for outdoor air) 6~12 kWh/m²
 - VRF (one outdoor and multi-indoor unit) <12 kWh/m²
- Central system: (less than 12 hours operation)
 - FCU with central OA: 20~45 kWh/m²
 - VAV: 30~45kWh/m²
- Different service modes make huge differences in energy used: P&P or F&F?

Indoor temperature level

- What is the set point temperature of indoor? 22°C ~ 28°C in different cases
 - With well humidity control at 60% around, 28°C is the most comfortable and health indoor state
 - 24°C or less make the occupancies fell cold, one of reasons may be the high humidity
 - Cold indoor environment with heavy clothes and huge cooling energy should not be the solution

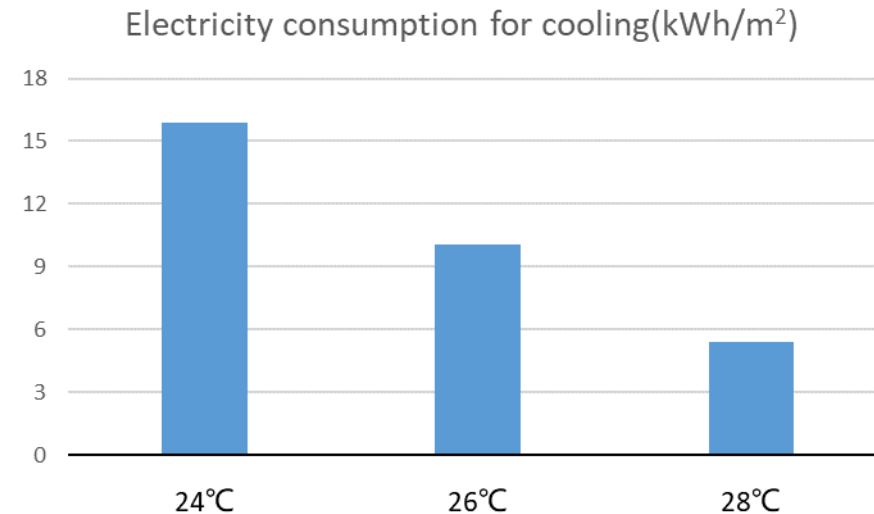
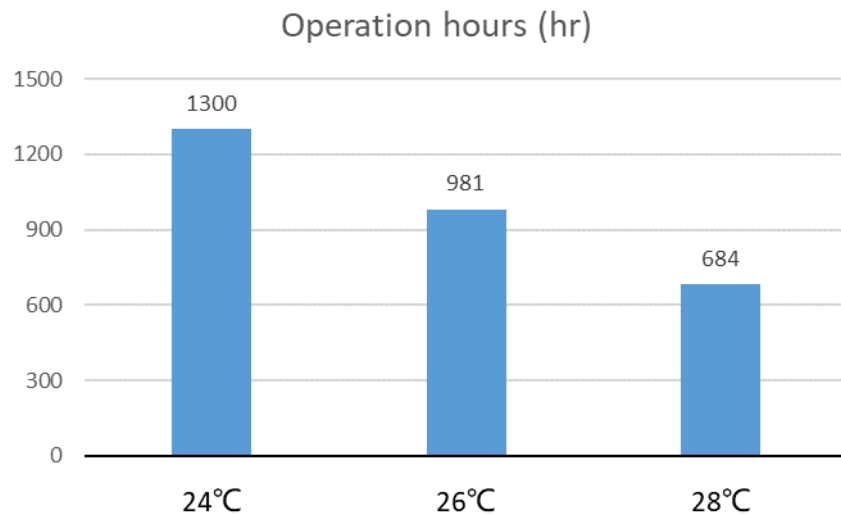

Reduce cooling demand by improvement of building design

- Natural ventilation
- External shading

- What about insulation of the building fabric?
- What about the air tightness?

Natural ventilation

- Daily highest & lowest dry-bulb temperature in China, Northern Europe, Western US

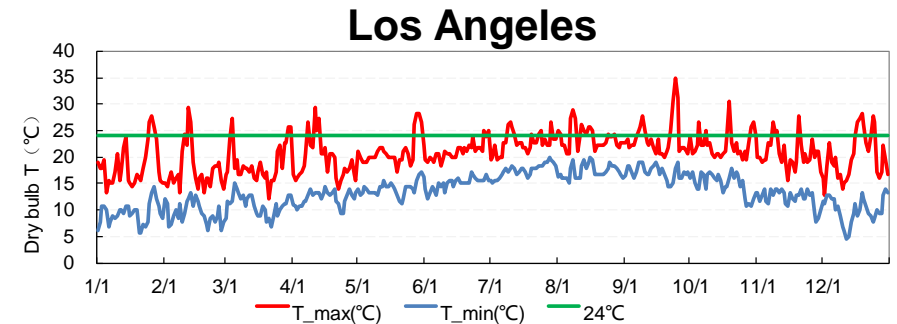
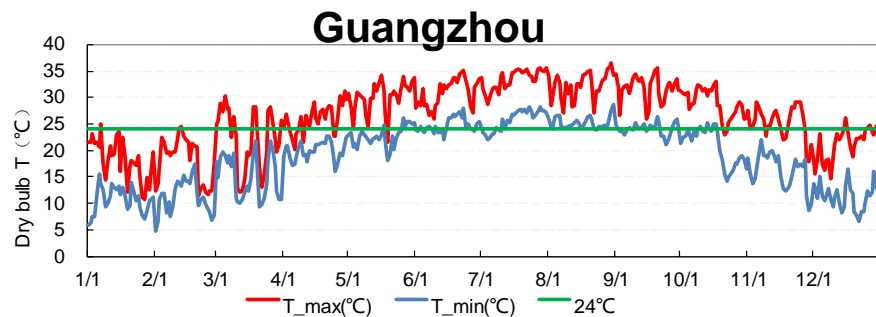
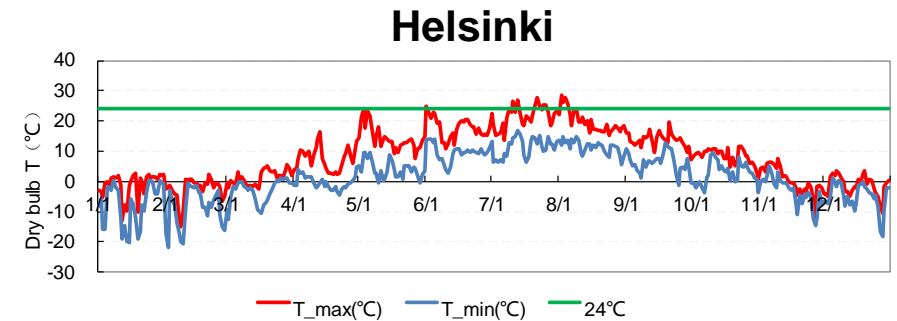
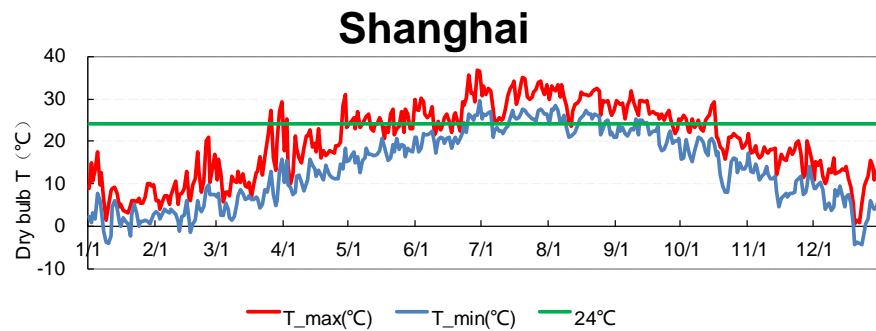
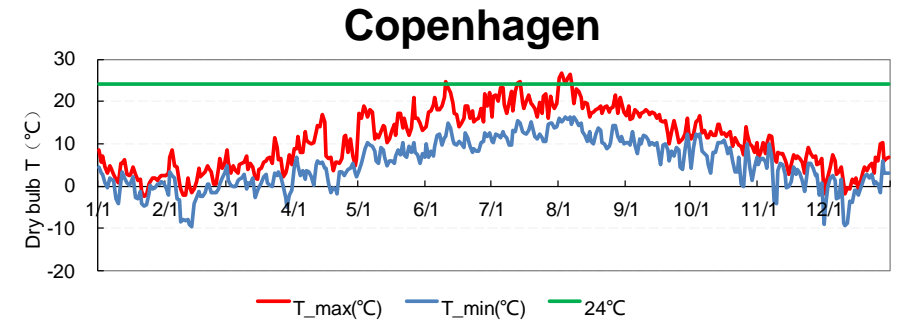
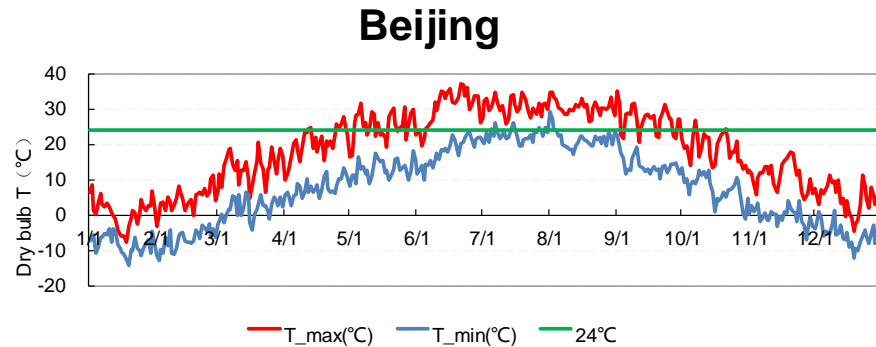

Reduce cooling demand by improvement of building design

- Major task for cooling is to **remove heat generated indoor** (50%~80%), rather than from outdoor
- **Natural ventilation can help to remove heat** from indoor to outdoor if outdoor temperature is lower than demand
- **Air tightness** is only needed when the outdoor enthalpy is higher than indoor
- If windows can be well designed both for ventilation when it is at open state and for good air tightness when it is closed, it should be very good. However if they cannot be satisfied both sides, **natural ventilation may should be the priority**
- Insulation of Wall is the similar situation, however, for heavy solar radiation, the temperature of wall surface can be much higher than outdoor temperature. In this case, **external shading** will be very important. Not only windows need shading, West walls, even east walls, do need external shading to avoid strong solar radiation.
- **Shading can reduce the effect of solar and keep the heat transferred from indoor to outdoor** if the outdoor air is cool. This means external shading is more important than insulation in terms of reduce cooling demand

Raising the cooling system efficiency

$$Energy = \frac{Cooling\ demand}{System\ COP}$$

- Reduce cooling demand: by promote P&P mode, suitable indoor set point, etc.
- Raising cooling system COP:
 - including chillers, pumps & fans
 - Total system COP is in the range 3 to 6 with current technologies available
 - If the COP of all cooling systems can reach 6 or above, cooling energy can save 30% or more
 - However in many cases the high COP can only appear at full load state, and suitable for F & F mode only, in this case, **convert P & P mode into F & F mode to raise COP may result in higher energy cost**
 - Develop system & device to support P & P mode with high COP should be the challenge in future

Reduce cooling demand should be the first option

- Part time & part space service rather than full time & full space
- Natural ventilation
- Building design: openable windows, external shading device, etc.
- Suitable indoor temperature set point, avoid over cooling
- Mechanical system should be selected or designed in coordinate with the practical use behaviors so the encourage the occupant saving behaviors

Avoid CFC in cooling system

- CFC as the refrigerant is higher global warming effect than CO₂
- Alternative approaches to replace compress cooling should also be emphasized and be supported
- Absorption chiller can meet the cooling demand without CFC
 - From energy point of view, the low efficiency of absorption chiller result in high CO₂ emission,
 - It only suitable when there are waste heat from industry
- Evaporation cooling
 - At dried climate it can provide good cooling service with low energy cost and free CFC

Indirect evaporative cooling

- Suitable for dry regions, No refrigerants, no CFC
- Cold water can be produced at the temperature between wet bulb and dew bulb of outside air

Indirect Evaporative Chiller

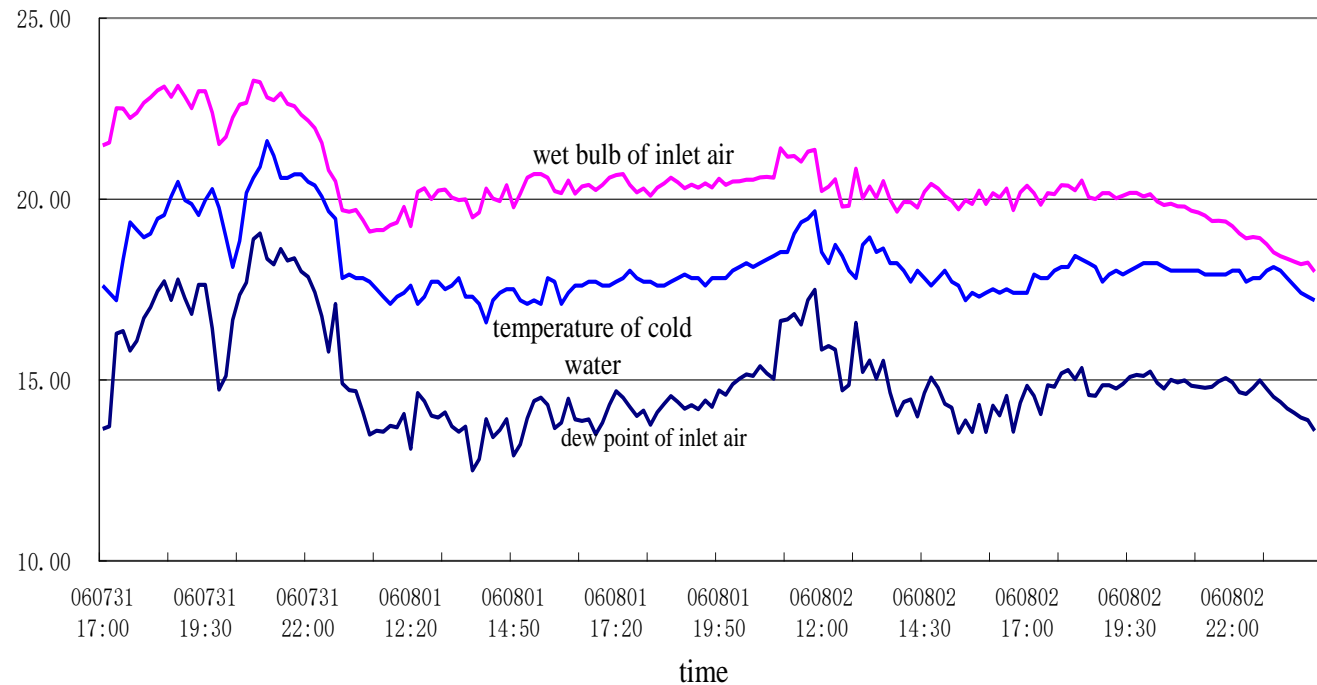

Indirect evaporative application prospect

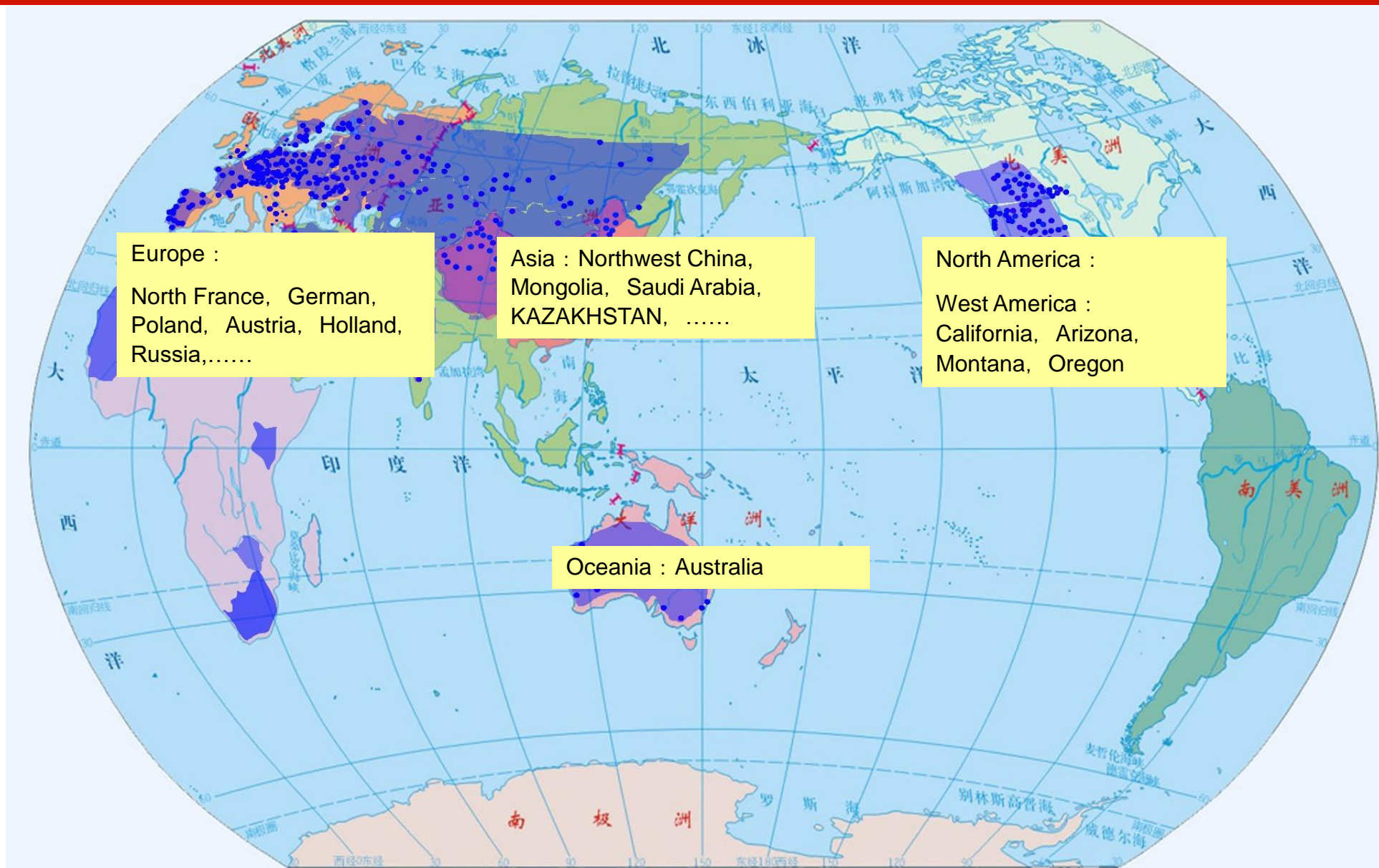

The approach for sustainable cooling

- Reduce cooling demand while meeting thermal comfort and improving living standards
 - Usage pattern (P & P mode, suitable temp setting point)
 - Building design : natural ventilation, external shading
 - Proper cooling system to adapt actual cooling behavior and demand : decentralized system
- Increase cooling energy efficiency, and decrease refrigerant leakage
 - Increase cooling efficiency under low load ratio
 - Recovery refrigerant of chillers during operation and decrease leakage
- Utilization of renewable energy and NO GWP cooling technology
 - Indirect evaporative cooling
 - Absorption cooling with industry waste heat

Conclusion

- Rapid growth of cooling demand due to climate change and urbanization will result in consequent energy consumption and carbon emission, as well as refrigerant leakage and global warming effect.
- Great potential comes from cooling system revolution and change of life style, this could lead to 2 to 3 times energy and emission difference
- Researchers and producers in cooling sector should not only focus on how to improve cooling efficiency, but also how to serve and adapt users' behavior and demand
- Revolutionize in cooling system form and usage pattern should be achieved, instead of follow historic path of developed countries, to meet the great challenge of global climate change and urbanization

Thanks!

jiangyi@tsinghua.edu.cn