

Field Calibration Facilities for Environmental Measurement of Radium, Thorium, and Potassium

Fourth Edition
October 2013

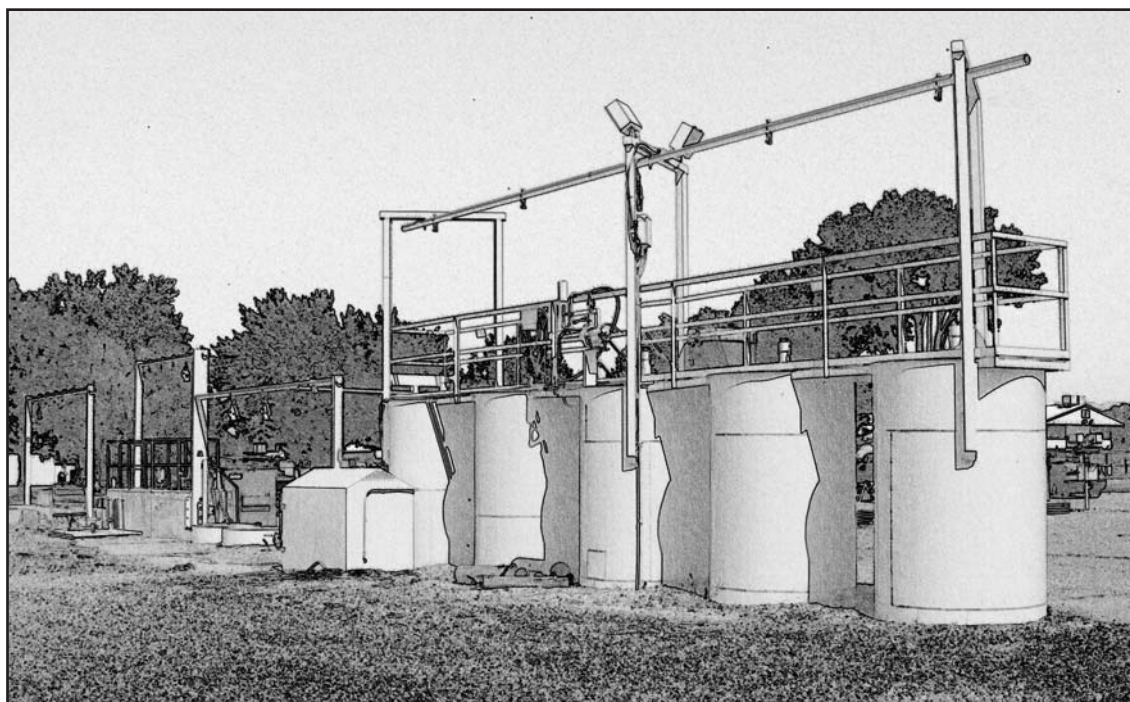

U.S. DEPARTMENT OF
ENERGY

Legacy
Management

This page intentionally left blank

**Field Calibration Facilities
for Environmental Measurement
of Radium, Thorium, and Potassium**

Fourth Edition

October 2013

This page intentionally left blank

Contents

Preface.....	iii
Summary.....	iv
1.0 Introduction and Discussion.....	1
1.1 Description of the Calibration Facilities.....	2
1.2 Characterization of the Calibration Facilities.....	3
2.0 Bibliography and References.....	7

Figure

Figure 1. Location of DOE Calibration Facilities.....	1
---	---

Tables

Table 1. Summary of Surface Calibration Facilities for Radiometric Instruments.....	4
Table 2. Summary of Subsurface Calibration Facilities for Radiometric Instruments.....	5
Table 3. Summary of Calibration Facilities for Density, Porosity, and Magnetic Susceptibility Instruments.....	6

Appendixes

Appendix A Primary Field Calibration Facilities

Map to Grand Junction Calibration Sites.....	A-2
Grand Junction Borehole Calibration Site.....	A-3
Layout of the Grand Junction Calibration Facility.....	A-4
Grand Junction Regional Airport Large-Area Calibration Pads.....	A-5
Grand Junction K, U, and T Models.....	A-6
Grand Junction KW Model.....	A-7
Grand Junction BL/BH, BT/BK, BU/BM, and BA/BB Models.....	A-8
Grand Junction N3, U1, U2, and U3 Models.....	A-10
Grand Junction WF Model.....	A-11
Grand Junction N1 Model.....	A-12
Grand Junction N2 Model.....	A-13
Grand Junction N4 Model.....	A-14
Grand Junction N5 Model.....	A-15
Grand Junction A Models.....	A-17
Grand Junction D Model.....	A-19
Grand Junction SW Model.....	A-20
Grand Junction SS/SB Model.....	A-21

Appendix B Secondary Field Calibration Facilities

Map to Casper, Wyoming, Calibration Site.....	B-2
Layout of Casper Calibration Site.....	B-3

Casper P Pads	B-4
Casper E Pads	B-5
Casper CBT/CBK, CBU/CBM, and CBA/CBB Models	B-6
Casper CH and CL Models	B-8
Map to Grants, New Mexico, Calibration Site	B-9
Layout of Grants Calibration Site	B-10
Grants P Pads	B-11
Grants E Pads	B-12
Grants GBT/GBK, GBU/GBM, and GBA/GBB Models.....	B-13
Grants GH and GL Models	B-15
Map to George West, Texas, Calibration Site.....	B-16
Layout of George West Calibration Site	B-17
George West P Pads	B-18
George West E Pads	B-19
George West TBT/TBK, TBU/TBM, and TBA/TBB Models.....	B-20
George West TH and TL Models	B-22

Appendix C Conversion Factors

Appendix D Example Conversion Factor Derivation

Appendix E Steel Casing Sections Available at the Grand Junction Facility

Appendix F Assignments for Logging Models; Enriched-Zone Grades as % $^{235}\text{U}_3\text{O}_8$

Preface

The first edition of this report, prepared by D.C. George and L. Knight and released in October 1982, presented physical-characteristic information for the various U.S. Department of Energy radiologic-instrument calibration facilities located throughout the United States. The second edition, released in August 1986, was an effort to provide the most current information available regarding the calibration facilities. The third edition was necessary to keep current with changes to the facilities. Three secondary field calibration facilities were decommissioned and several models were added to or removed from the primary calibration facility. Since the third edition was published in June 1994 several more calibration models have been decommissioned. This fourth edition continues the effort of updating information regarding the current status of the facilities. Every attempt has been made to ensure that the information presented is accurate.

Summary

This report describes calibration facilities located at Grand Junction, Colorado, and at three secondary calibration sites. These facilities are available for the calibration of radiometric field instrumentation for in situ measurements of radium (uranium), thorium, and potassium.

The U.S. Department of Energy and its predecessor agencies constructed all of the calibration facilities described herein for use in annual uranium-reserve determinations and to support uranium exploration. Concentration units expressed in equivalent percent U_3O_8 in the original edition were converted to units of picocuries/gram radium as the facilities were mainly used for calibration of equipment used during remediation of numerous Uranium Mill Tailings Radiation Control Act sites. The use of these facilities for the calibration of radiometric field instruments used in remedial action is made possible by the commonality of the radiometric measurement technique for uranium and radium. Table ES-1, "Assignments for Logging Models," from the 1983 *Grade Assignments for Models Used for Calibration of Gross-Count Gamma-Ray Logging Systems*, has been included in this release with grade assignment values expressed in units of % eU_3O_8 as Appendix F.

1.0 Introduction and Discussion

The U.S. Department of Energy (DOE) Office of Legacy Management (LM) has the responsibility to maintain legacy calibration facilities for environmental radioelement measurements at one primary and three satellite borehole geophysical calibration facilities. The Department also maintains and provides access to the large area calibration pads located at the Grand Junction Regional Airport.

Since the 1950s, DOE and its predecessor agencies developed facilities for calibrating gamma-ray measuring instruments used in uranium exploration. These facilities are also suitable for calibration of gamma-ray instruments used for remedial action measurements; specifically, in situ assays for natural radionuclides.

The borehole facilities serve as standards for calibration of high-resolution passive gamma logging systems. Standards are also available for the calibration of fission neutron logging devices. The Gamma Water Factor, KUT Water Factor, and the D model in Grand Junction are designed with various sized boreholes to determine water factor calibration curves. Several different sizes of steel casings are available at the Grand Junction facility to determine casing factor calibration curves (Appendix E).

The calibration facilities are available for use free of charge at four sites located throughout the United States (Figure 1). The primary calibration facilities are located at Grand Junction, Colorado, and secondary facilities are located at each of three sites: Casper, Wyoming; Grants, New Mexico; and George West, Texas.



Figure 1. Location of DOE Calibration Facilities

Borehole models at all of the sites are kept locked to prevent unauthorized access. Keys are available to authorized users by contacting the LM contractor responsible for site security. Users who are not American citizens normally require a 30 day prior notice for access. Please check the website for current information.

Access to the Large-Area Pads at the Grand Junction Regional Airport now requires an escort with a Transportation Security Administration badge. Users planning calibrations at the airport pads must contact the DOE contractor at the number below to schedule access.

To use any of the facilities described in this report, contact the LM contractor at:

Calibration Facilities
2597 Legacy Way
Grand Junction, CO 81503
Phone: (970) 248-6000
Fax: (970) 248-6040

Current information regarding the facilities is provided on the US DOE-LM Calibration Facilities website at: <http://energy.gov/lm/services/calibration-facilities>. This website includes geophysical logging and calibration method documents available for download.

All users must report any use of the facilities via the Calibration Facilities website link for that purpose or via U.S. mail to:

Calibration Facilities
2597 Legacy Way
Grand Junction, CO 81503

1.1 Description of the Calibration Facilities

The calibration facilities provide distributed sources of radium, thorium, and/or potassium. In general, they were constructed by enriching a concrete mix with uranium ore, monazite sand, and/or orthoclase sand. The facilities consist of pads and borehole models with the following characteristics:

- Cylinders approximately 4 feet in diameter by 2 feet high, referred to as "scintillometer pads," "spectrometer pads," or simply "pads."
- Large-area slabs, 30 feet by 40 feet and 1.5 feet thick, referred to as "Airport pads" because they are located at the Grand Junction Regional Airport in Grand Junction, Colorado.
- Cylinders and other equivalent configurations approximately 4 feet in diameter and up to 30 feet deep containing boreholes along their axes, referred to as "borehole models" or simply "pits."

This report presents descriptions of the facilities and the accompanying physical-characteristic information contained in Appendixes A and B. The values for radioelement concentrations within the models and pads use information from studies conducted by George, Heistand, and Krabacher (1983); Heistand and Novak (1984); and George, Novak, and Price (1985).

Information concerning dimensional descriptions of the models and pads, as well as maps to all of the calibration sites, has been updated as required to reflect the latest available information. Concepts and details of calibration procedures for specific instruments are beyond the scope of this report; however, many of these procedures are presented in other reports (Marutzky and others 1984; George and Price 1982).

1.2 Characterization of the Calibration Facilities

Over the years, several studies have been performed to characterize the models and pads referred to in this document. The information provided in this fourth edition regarding the calibration facilities is as current as possible although no new characterization has been conducted. Instead, this edition was completed to reflect the current status of the facilities.

Concentrations were not assigned for the barren zones of the models in any of the recent studies. Consequently, barren-zone data have not been included in this report. Because some parameters for the Grand Junction A and D Models were not reassigned, the original assignments have been included here in an effort to present the most complete data set possible. Footnotes presented with each data set are intended to clarify the origin of the assigned parameters.

Tables 1, 2, and 3 are summary descriptions of pads and models at the calibration facilities. The entries in the column labeled "Intended Use" are not necessarily intended to be restrictions on the use of the calibration facility, because some models and pads are useful for several instrument types and applications. The entries in the column labeled "Approximate Concentration" are meant only for order-of-magnitude comparisons. More precise values for the models and pads can be found in Appendixes A and B. The entries in the column labeled "Notes" suggest appropriate uses for the pads and models.

Discussions of calibration procedures for specific instrument types can be found in reports by Marutzky et al. (1984) and George and Price (1982).

Several units of measure have been used over the years to represent radionuclide concentrations. The main use of the facility in recent years was for calibration of instruments used during remediation of the various Uranium Mill Tailings Radiation Control Act (UMTRCA) sites. Cleanup standards used during remediation were units of radium in picocuries/gram to comply with U.S. Environmental Protection Agency regulations. All concentrations stated herein are reported in picocuries per gram. Useful conversion factors are presented in Appendix C. In addition, Appendix C contains the constants used to derive these conversion factors. The derivation of the conversion factors is discussed in Appendix D.

Appendix F, "Enriched-Zone Grades as % eU_3O_8 ," is provided to provide borehole grade assignment data in units of % eU_3O_8 as presented in *Grade Assignments for Models Used for Calibration of Gross-Count Gamma-Ray Logging Systems* (George et al. 1983). Airport pad concentration values in units of ppm uranium, ppm thorium, and percent potassium have also been included.

Table 1. Summary of Surface Calibration Facilities for Radiometric Instruments

Intended Use	Pad Designation	Approximate Concentration ^a			Location ^c	Notes
		Potassium-40 (pCi/g)	Radium-226 ^b (pCi/g)	Thorium-232 ^b (pCi/g)		
Portable or Mobile Instrument Calibrations	W1	10	1	1	Grand Junction Regional Airport	These large-area pads, 30 ft by 40 ft, are intended for calibration of spectral "surface surveying" or airborne instruments.
	W2	50	2	1		
	W3	20	2	5		
	W4	20	10	1		
	W5	50	8	2		
Portable Scintillometer and Spectrometer Calibrations	XPK ^d	50	1	0	NM, TX, WY	These pads are intended for calibration of both scintillometers and spectral instruments.
	XPL ^d	15	80	1		
	XPH ^d	15	400	1		
	XPT ^d	15	7	30		
	XPB ^d	0	0	0		
Portable Scintillometer Calibrations	XE2 ^d	10	80	1	NM, TX, WY	These pads are intended for calibration of portable total-count instruments.
	XE4 ^d	10	400	1		

^a Concentrations shown are rounded to order of magnitude for purposes of comparison. Consult data sheets in Appendixes A and B for concentrations to be used for calibration.

^b Values tabulated are radiometric equivalent (e) concentrations; see Appendixes C and D.

^c NM, TX, WY—secondary sites as explained in footnote d.

^d The X designates any of the three secondary sites. WY—Casper, Wyoming; NM—Grants, New Mexico; TX—George West, Texas.

Table 2. Summary of Subsurface Calibration Facilities for Radiometric Instruments

Intended Use	Model Designation	Approximate Concentration ^a			Location ^c	Notes
		Potassium-40 (pCi/g)	Radium-226 ^b (pCi/g)	Thorium-232 ^b (pCi/g)		
Spectral Logging System Calibrations	K	50	1	2	GJO	The K, U, and T models are used to determine stripping factors for spectral logging systems. The U, BU, and XBU models are useful for Ra calibrations for total-count systems. The KW model has five different borehole diameters; the enriched middle zone is a mixture of Ra-Th-K.
	U	10	160	6		
	T	10	10	500		
	KW	40	120	200		
	BK, XBK ^d	50	1	0.09	All Sites	
	BU, XBU ^d	10	200	8		
	BT, XBT ^d	10	10	68		
	BM, XBM ^d	40	130	50		
Gross-Gamma Total-Count Logging System Calibrations	N3, U1		700; 7,000		GJO	The high concentrations of models in this group make them unsuitable for some logging systems. Lower "radium-only" concentrations can be found in other models. The WF model is useful for water, casing, and hole size corrections; the D model has a lower Ra concentration and is similar to the WF model.
	U2, U3		3,000; 1,500			
	WF		800			
	XL, XH ^d		800; 6,000		NM, TX, WY	
	BL, BH, XBL, XBH ^d		300; 3,000		GJO	
Total-Count Logging Systems Measurements	N1		700		GJO	The high concentrations of these models make them unsuitable for some logging systems. These models are for experimental use.
	N2		1,200			
	N4		700; 2,600			
	N5		300; 600; 700; 2,700; 4,900			
Fission-Neutron Logging System Calibrations	A1, A2, A3, A4, A5, A6		90, 200, 500, 600, 200, 200		GJO	These models are intended for fission-neutron logging system calibrations. However, they are useful for gamma-ray system calibrations if they have not been recently used with a neutron source. The D model has seven different borehole diameters.
	D		200			
	BA, BB, XBA, XBB ^d		60, 800, 900		All Sites	

^a Concentrations shown here are rounded to order of magnitude for purposes of comparison. Consult data sheets in Appendixes A and B for concentrations to be used for calibration.

^b Values tabulated are radiometric equivalent (e) concentrations, see Appendixes C and D.

^c GJO—Grand Junction Office; WY, NM, TX—secondary sites as explained in footnote d.

^d BK, BU, BT, and BM are in Grand Junction. The X designates any of the three secondary sites. WY—Casper, Wyoming; NM—Grants, New Mexico; TX—George West, Texas.

Table 3. Summary of Calibration Facilities for Density, Porosity, and Magnetic Susceptibility Instruments

Intended Use	Pad Designation	Porosity (vol %)	Dry Bulk Density (g/cm ³)	Location	Notes
Moisture/Porosity and Density	SW	40	1.6	GJO ^a	These models are intended for calibration of moisture/porosity and/or density measurement systems. Model SW is water and sand and also is suitable for tool background determination.
	SS	20	2.2		
	SB	5	2.6		

^a GJO—Grand Junction Office

Intended Use	Pad Designation	Magnetic Susceptibility (μCGS)	Dry Bulk Density (g/cm ³)	Location	Notes
Magnetic Susceptibility Calibration ^b	Granite Block ^b	385	2.63	Grand Junction UMTRCA Disposal Cell	This model is intended for calibration of magnetic susceptibility measurement systems. The granite block is currently stored at the Grand Junction UMTRCA Disposal Cell, approximately 15 miles south of the GJ calibration facility.

^b Model is in storage and not normally available to the public.

2.0 Bibliography and References

Bristow, Q., J. Conaway, and P. Killeen, 1984. "Application of Inverse Filtering to Gamma-Ray Logs: A Case Study," *Geophysics*, Volume 49, Number 8, pp. 1369–1373.

Brodeur, J.R., C.J. Koizumi, W.H. Ulbricht, and R.K. Price, 1991. *Calibration of a High-Resolution Passive Gamma-Ray Logging System for Nuclear Waste Assessment*, Proceedings of the Fourth International Symposium on Borehole Geophysics for Minerals, Geotechnical, and Groundwater Applications, Minerals and Geotechnical Logging Society, Toronto, Ontario (Canada).

Emilia, D.A., J.W. Allen, R.B. Chessmore, and R.B. Wilson, 1981. *The DOE/Simplec Magnetic Susceptibility Logging System*, GJBX-75(81), Bendix Field Engineering Corporation, Grand Junction Office, U.S. Department of Energy, Grand Junction, Colorado, and Simplec Manufacturing Co., Inc. (Wilson), Dallas, Texas, March 1981.

George, D.C., 1986. *Parameter Assignments for Sandstone Models*, Internal Memorandum, Bendix Field Engineering Corporation, Grand Junction, Colorado, July 17, 1986.

George, D.C., and R.K. Price, 1982. *Abbreviated Total-Count Logging Procedures for Use in Remedial Action*, GJ/TMC-03(82), Technical Measurements Center, U.S. Department of Energy, Grand Junction Area Office, Grand Junction, Colorado.

George, D.C., B.E. Heistand, and J.E. Krabacher, 1983. *Grade Assignments for Models Used for Calibration of Gross-Count Gamma-Ray Logging Systems*, GJBX-39(83), Bendix Field Engineering Corporation, Grand Junction, Colorado.

George, D.C., E.F. Novak, and R.K. Price, 1985. *Calibration-Pad Parameter Assignments for In Situ Gamma-Ray Measurements of Radium, Thorium, and Potassium*, GJ/TMC-17, Technical Measurements Center, U.S. Department of Energy, Grand Junction Projects Office, Grand Junction, Colorado.

Heistand, B.E., and E.F. Novak, 1984. *Parameter Assignments for Spectral Gamma-Ray Borehole Calibration Models*, GJBX-2(84), Bendix Field Engineering Corporation, Grand Junction, Colorado.

Koizumi, C.J., 1979. *Logging Calibration Models for Fission Neutron Sondes*, GJBX-267(81), Bendix Field Engineering Corporation, Grand Junction, Colorado.

Koizumi, C.J., 1980. *Thin, Dipping Ore Zone Logging Models: Log Studies*, GJBX-54(80), Bendix Field Engineering Corporation, Grand Junction Operations, U.S. Department of Energy, Grand Junction, Colorado.

Koizumi, C.J., J.R. Brodeur, W.H. Ulbricht, and R.K. Price, 1991. *Calibration of the RLS HPGe Spectral Gamma Ray Logging System*, Westinghouse Hanford Company, publication WHC-EP-0464, Richland, Washington.

Koizumi, C.J., J.R. Brodeur, R.K. Price, J.E. Meisner, and D.C. Stromswold, 1994. "High-Resolution Gamma-Ray Spectrometry Logging for Contamination Assessment," *Nuclear Geophysics*, Volume 8, Number 2.

Lederer, C.M., and V.S. Shirley (eds.), 1978. *Table of Isotopes*, Seventh Edition, John Wiley and Sons, New York, New York.

Marutzky, S.J., W.D. Steele, B.N. Key, and K.L. Kosanke, 1984. *Surface Gamma-Ray Measurement Protocol*, GJ/TMC-06, Technical Measurements Center, U.S. Department of Energy, Grand Junction Projects Office, Grand Junction, Colorado.

Matthews, M., 1975. *Data Compendium for the Logging Test Pits at the ERDA Grand Junction Compound*, Bendix Field Engineering Corporation, Grand Junction, Colorado.

Novak, E.F., 1988. *Exposure-Rate Calibration Using Large-Area Calibration Pads*, DOE/ID/12584-25, U.S. Department of Energy, Grand Junction Projects Office, Grand Junction, Colorado, September.

Walker, F.W., G.J. Kirouac, and F.M. Rourke, 1977. *Chart of the Nuclides*, Twelfth Edition, General Electric Corporation, San Jose, California.

Appendix A

Primary Field Calibration Facilities

This page intentionally left blank

Primary Field Calibration Facilities

This appendix presents detailed information concerning location, layout, pad and model descriptions, and radioelement concentrations for the primary calibration facilities at Grand Junction, Colorado. These facilities are administered, maintained, and operated by the U.S. Department of Energy Office of Legacy Management.

Map to Grand Junction, CO, Calibration Sites

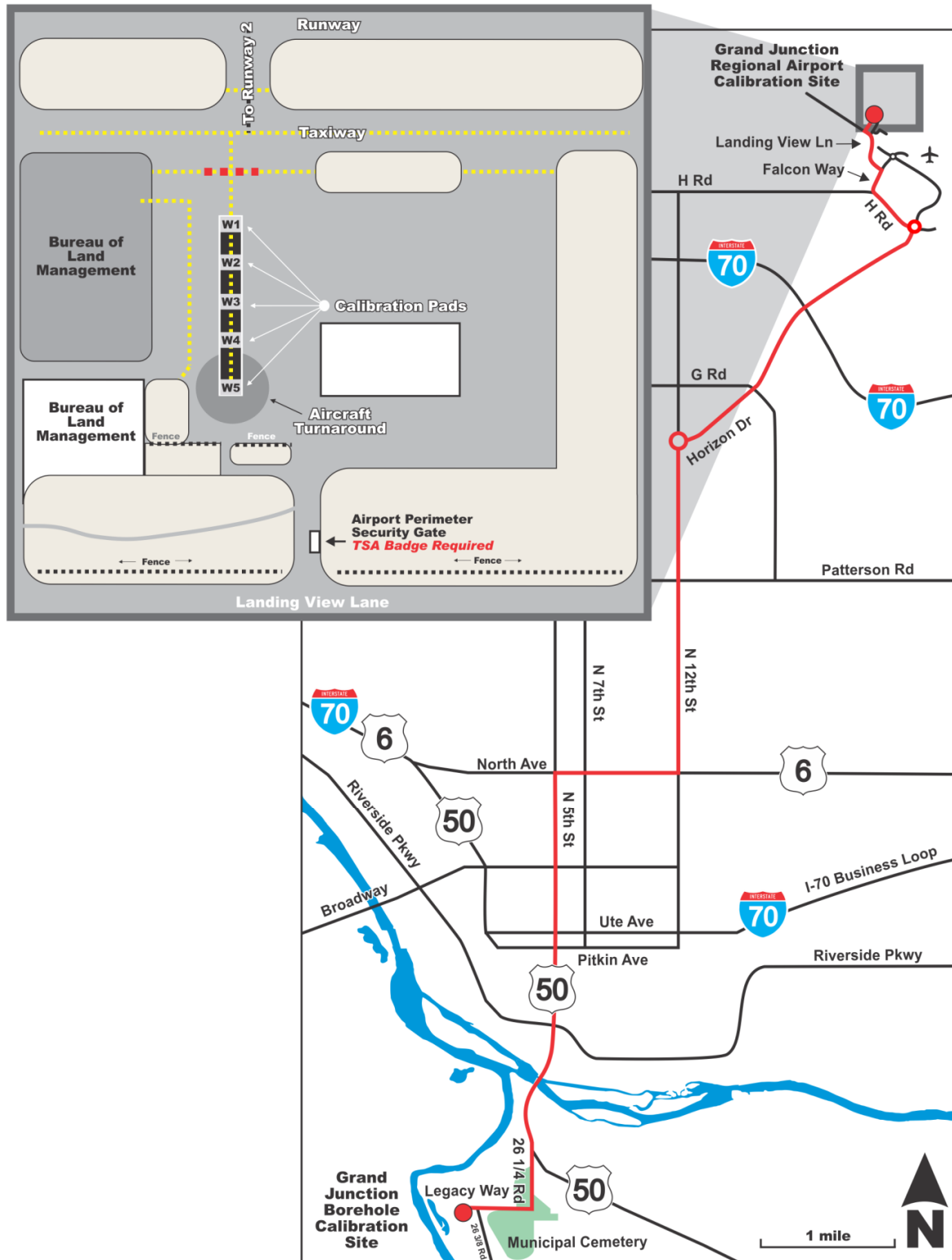

Map to Grand Junction Calibration Sites

Grand Junction Borehole Calibration Site

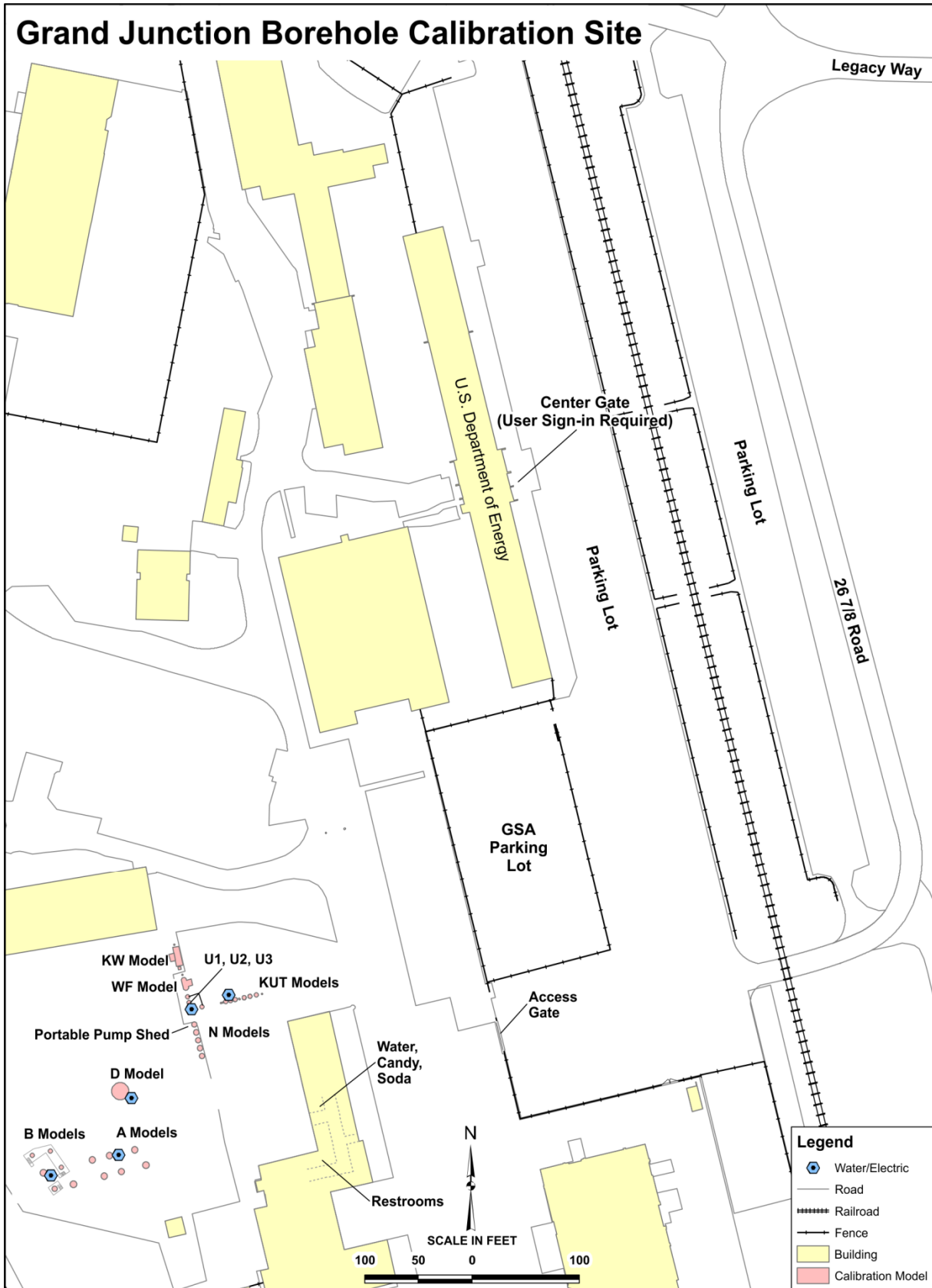

M:\LTS\111\0058\05\IS03471\IS0347100.mxd coatesc 10/7/2008 11:48:56 AM

Grand Junction Borehole Calibration Site

Layout of Grand Junction Calibration Facility

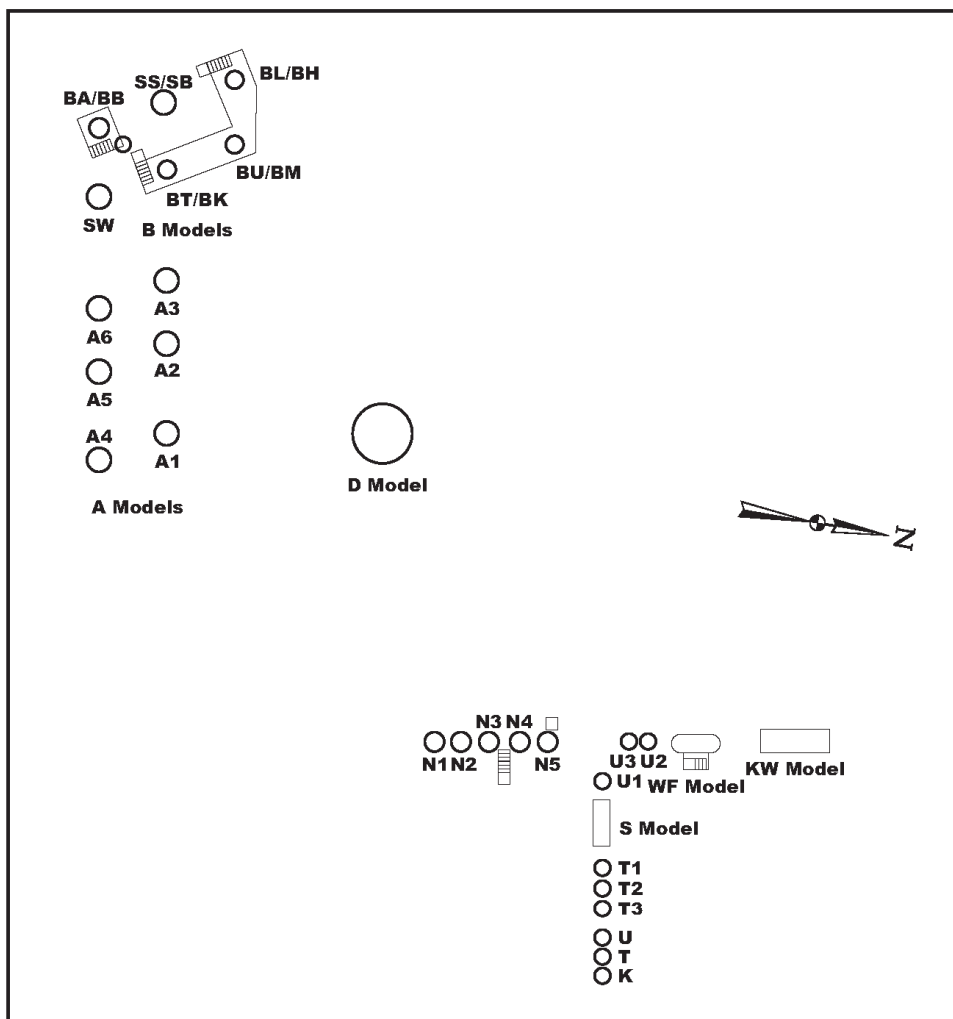

Map not to scale.

- Borehole Model
- Surface Pad

Layout of the Grand Junction Calibration Facility

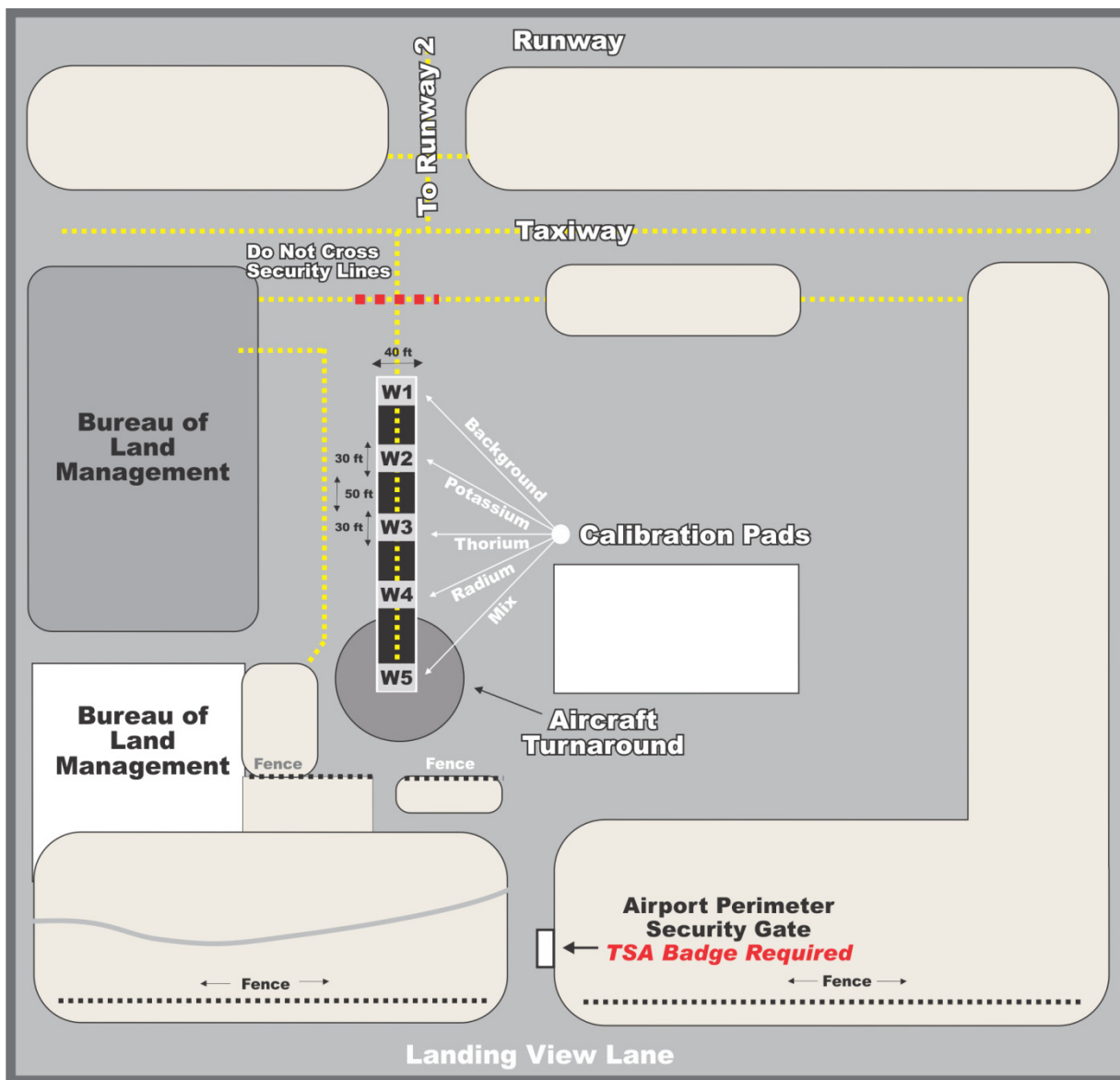

Grand Junction Regional Airport Large-Area Calibration Pads

Table A-1. Assigned Parameters

Pad Designation	Concentration (pCi/g) ^a			Dry Bulk Density (g/cm ³) ^b	Partial Density H ₂ O (g/cm ³) ^b
	Ra-226	Th-232	K-40		
W1	0.82 ± 1.02	0.67 ± 0.10	12.67 ± 0.72	1.91	0.256
W2	1.92 ± 1.54	0.87 ± 0.12	45.58 ± 1.82	1.99	0.260
W3	1.70 ± 1.38	4.92 ± 0.26	17.07 ± 0.82	1.92	0.208
W4	12.07 ± 5.64	1.04 ± 0.12	17.56 ± 0.98	1.91	0.247
W5	8.36 ± 3.52	1.91 ± 0.16	34.68 ± 1.46	1.97	0.244

^a Uncertainties are 95 percent confidence level. Assigned values taken from George et al. (1985).

^b Uncertainties for these values have not been determined.

Grand Junction K, U, and T Models

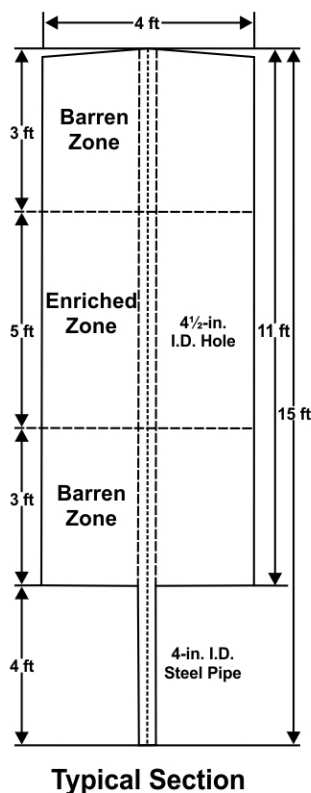

Grand Junction K, U, and T Models

Table A-2. Assigned Parameters for Calibration of Spectral Gamma-Ray Logging Systems

Model Designation	Zone	Concentration (pCi/g) ^a			Dry Bulk Density (g/cm ³) ^b	Partial Density H ₂ O (g/cm ³) ^b
		Ra-226	Th-232	K-40		
K	Enriched	0.92 ± 0.09	0.28 ± 0.03	52.24 ± 1.67	1.86	0.269
U	Enriched	162.9 ± 5.34	0.73 ± 0.06	10.21 ± 0.84	1.89	0.274
T	Enriched	8.47 ± 0.47	53.03 ± 1.49	10.38 ± 1.17	1.88	0.275

^a Uncertainties are 95 percent confidence level. Assigned values taken from Heistand and Novak (1984).

^b Uncertainties for these values have not been determined.

Table A-3. Assigned Parameters for Calibration of Total-Count Gamma-Ray Logging Systems

Model Designation	Zone	Ra-226 Concentration (pCi/g) ^a	Thickness (ft) ^b	Dry Bulk Density (g/cm ³) ^c	Partial Density H ₂ O (g/cm ³) ^c
U	Enriched	158 ± 6.0	4.98 ± 0.00	1.89	0.274

^a Uncertainties are 95 percent confidence level. Assigned value taken from George et al. (1983).

^b Uncertainty reported as 0.00 is not zero, but is less than 0.01 ft.

^c Uncertainties for these values have not been determined.

Grand Junction KW Model

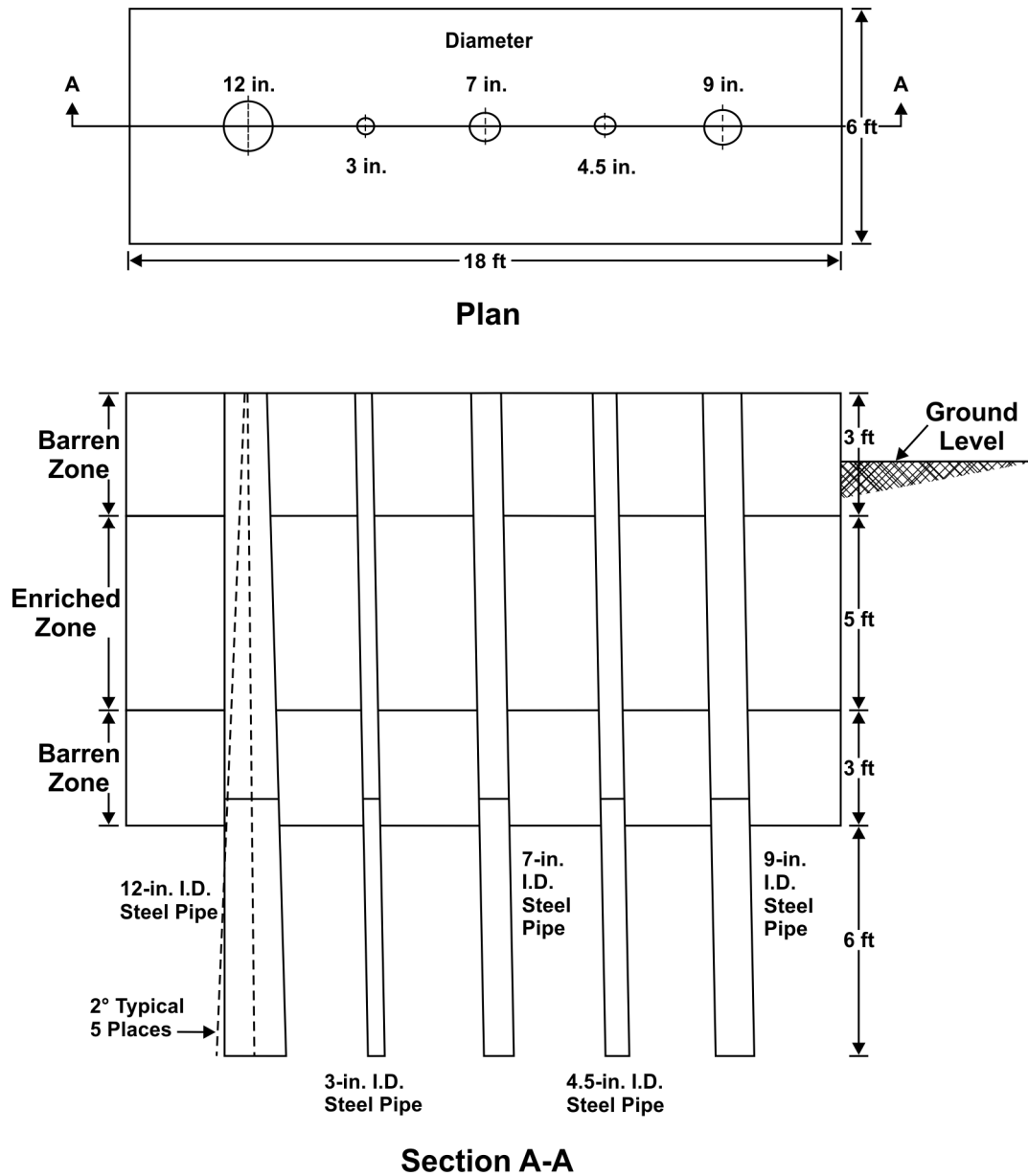

Grand Junction KW Model

Table A-4. Assigned Parameters for Calibration of Spectral Gamma-Ray Logging Systems

Model Designation	Zone	Concentration (pCi/g) ^a			Dry Bulk Density (g/cm ³) ^b	Partial Density H ₂ O (g/cm ³) ^b
		Ra-226	Th-232	K-40		
KW	Enriched	120.55 ± 4.00	26.71 ± 0.79	38.43 ± 1.67	1.86	0.264

^a Uncertainties are 95 percent confidence level. Assigned values taken from Heistand and Novak (1984).

^b Uncertainties for these values have not been determined.

Grand Junction BL/BH, BT/BK, BU/BM, and BA/BB Models

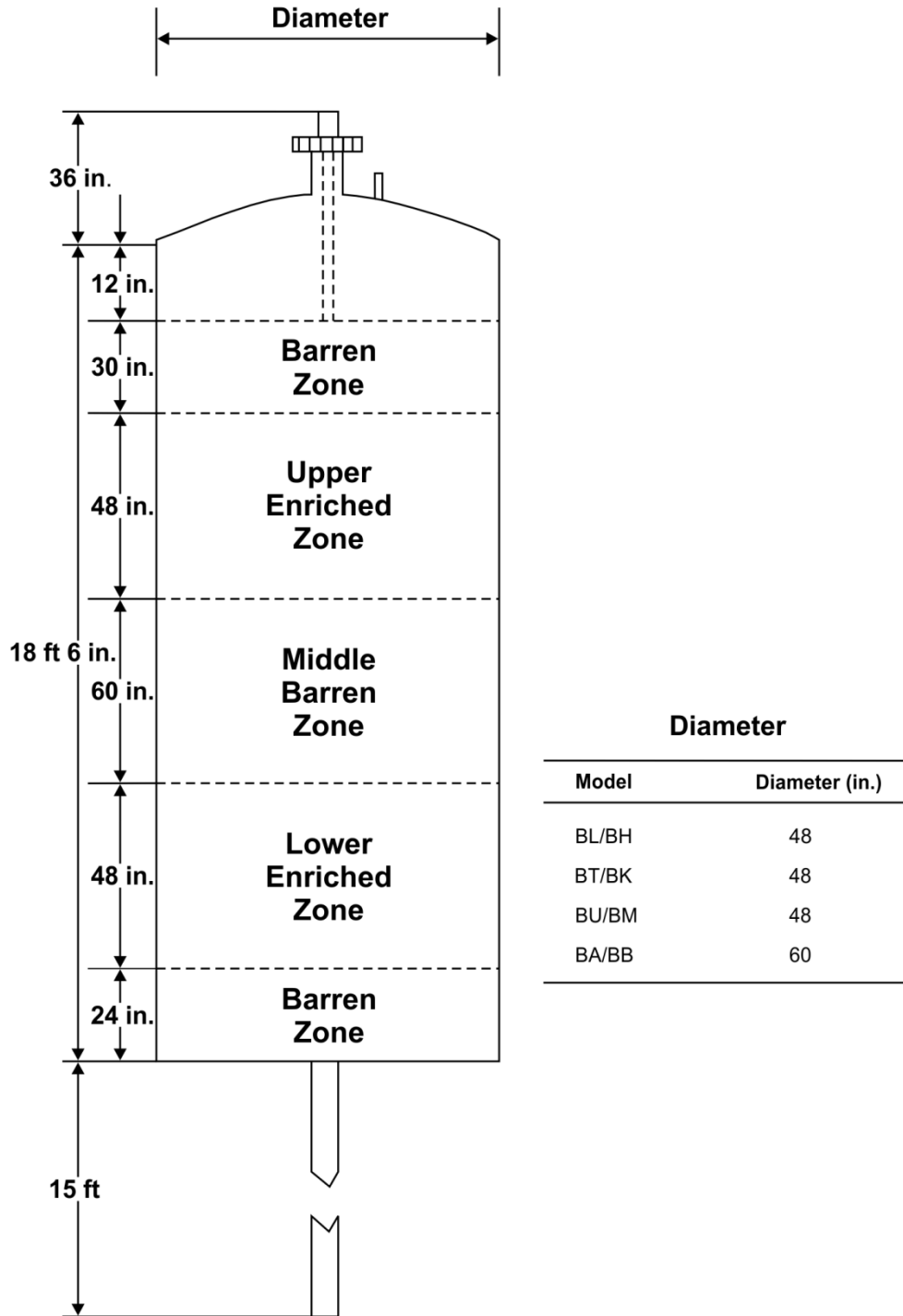

Grand Junction BL/BH, BT/BK, BU/BM, and BA/BB Models

Table A-5. Assigned Parameters for Calibration of Total-Count Gamma Logging Systems

Model Designation	Zone	Ra-226 Concentration (pCi/g) ^a	Thickness (ft) ^b	Dry Bulk Density (g/cm ³) ^c	Partial Density H ₂ O (g/cm ³) ^c
BU	Upper	188 ± 6	4.01 ± 0.02	1.91	0.243
BL	Upper	334 ± 9	3.97 ± 0.00	2.23	0.188
BH	Lower	3,136 ± 181	4.00 ± 0.02	2.22	0.196
BA	Upper	62.4 ± 1.8	3.99 ± 0.00	2.22	0.187
BB	Lower	913 ± 27	3.97 ± 0.00	2.21	0.188

^a Uncertainties are 95 percent confidence level. Assigned values taken from George et al. (1983).

^b Uncertainties reported as 0.00 are not zero, but are less than 0.01 ft.

^c Uncertainties for these values have not been determined.

Table A-6. Assigned Parameters for Calibration of Spectral Gamma-Ray Logging Systems

Model Designation	Zone	Concentration (pCi/g) ^a			Dry Bulk Density (g/cm ³) ^b	Partial Density H ₂ O (g/cm ³) ^b
		Ra-226	Th-232	K-40		
BT	Upper	10.46 ± 0.51	58.78 ± 1.53	10.13 ± 1.34	1.91	0.244
BK	Lower	1.03 ± 1.67	0.10 ± 0.02	54.00 ± 1.67	1.81	0.250
BU	Upper	194.59 ± 5.94	0.65 ± 0.06	10.63 ± 1.00	1.91	0.243
BM	Lower	131.16 ± 4.07	40.12 ± 1.09	42.86 ± 2.01	1.88	0.251

^a Uncertainties are 95 percent confidence level. Assigned values taken from Heistand and Novak (1984).

^b Uncertainties for these values have not been determined.

Table A-7. Assigned Parameters for Calibration of Fission-Neutron Logging Systems

Model Designation	Zone	Ra-226 Concentration (pCi/g) ^a	Thickness (ft) ^b	Dry Bulk Density (g/cm ³) ^c	Partial Density H ₂ O (g/cm ³) ^c
BA	Upper	62.4 ± 1.8	3.99 ± 0.00	2.22	0.187
BB	Lower	913 ± 27	3.97 ± 0.00	2.21	0.188

^a Uncertainties are 95 percent confidence level. Assigned values taken from George et al. (1983).

^b Uncertainties reported as 0.00 are not zero, but are less than 0.01 ft.

^c Uncertainties for these values have not been determined.

Grand Junction N3, U1, U2, and U3 Models

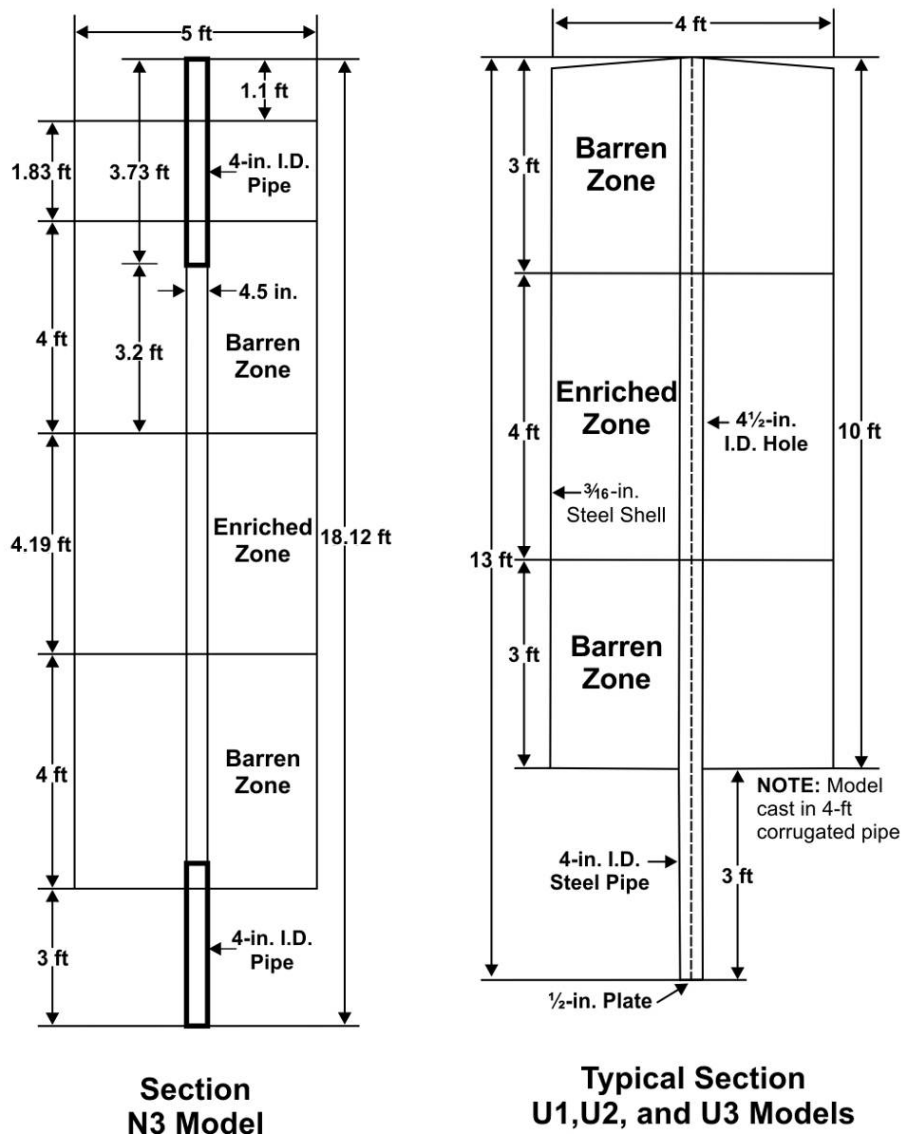

Grand Junction N3, U1, U2, and U3 Models

Table A-8. Assigned Parameters for Calibration of Total-Count Gamma-Ray Logging Systems

Model Designation	Zone	Ra-226 Concentration (pCi/g) ^a	Thickness (ft) ^b	Dry Bulk Density (g/cm ³) ^c	Partial Density H ₂ O (g/cm ³) ^c
N3	Enriched	654 ± 23	4.19 ± 0.00	1.83	0.281
U1	Enriched	7,460 ± 465	4.06 ± 0.02	2.07	0.255
U2	Enriched	3,478 ± 218	4.01 ± 0.00	1.70	0.295
U3	Enriched	1,278 ± 51	4.01 ± 0.00	1.67	0.304

^a Uncertainties are 95 percent confidence level. Assigned values taken from George et al. (1983).

^b Uncertainties reported as 0.00 are not zero, but are less than 0.005 ft.

^c Uncertainties for these values have not been determined.

Grand Junction WF Model

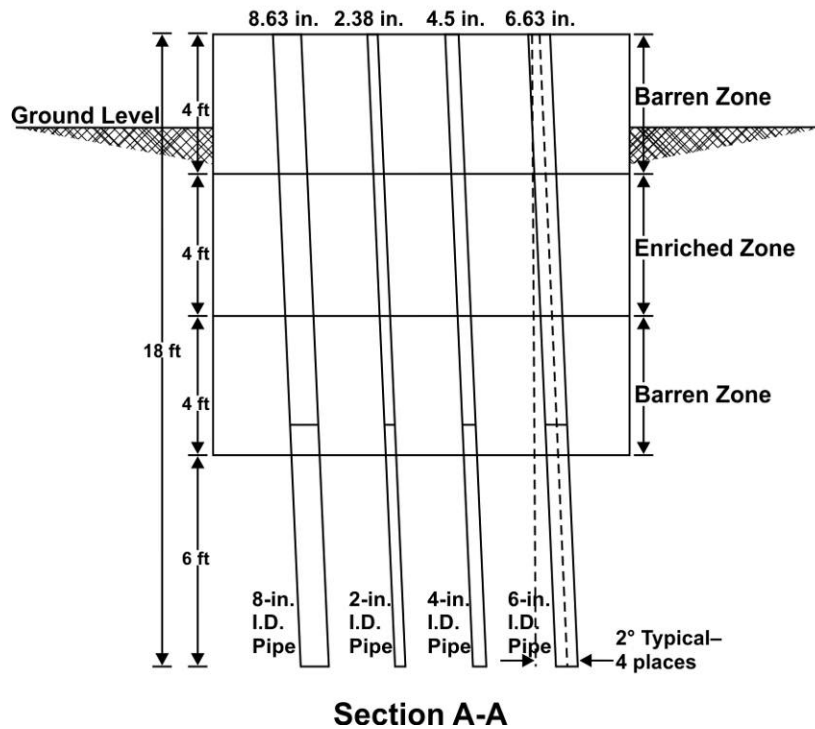
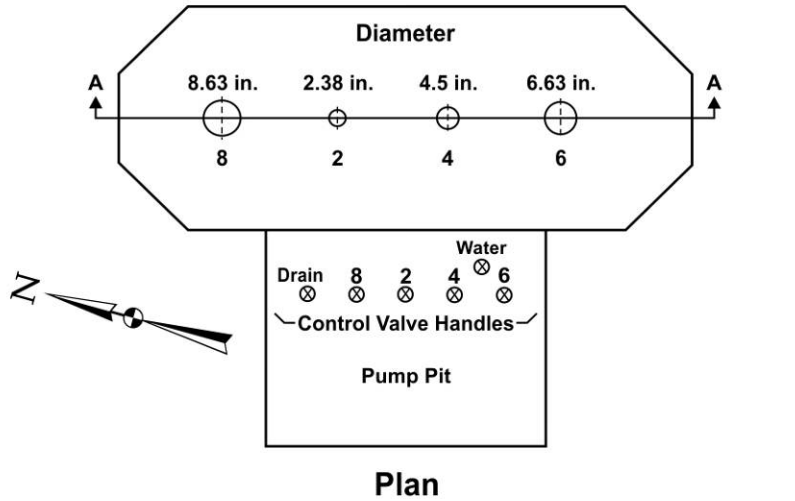

Grand Junction WF Model

Table A-9. Assigned Parameters for Calibration of Total-Count Gamma-Ray Logging Systems

Model Designation	Zone	Ra-226 Concentration (pCi/g) ^a	Thickness (ft) ^b	Dry Bulk Density (g/cm ³) ^c	Partial Density H ₂ O (g/cm ³) ^c
WF	Enriched	850 ± 30	4.02 ± 0.00	1.86	0.282

^a Uncertainties are 95 percent confidence level. Assigned values taken from George et al. (1983).

^b Uncertainties reported as 0.00 are not zero, but are less than 0.005 ft.

^c Uncertainties for these values have not been determined.

Grand Junction N1 Model

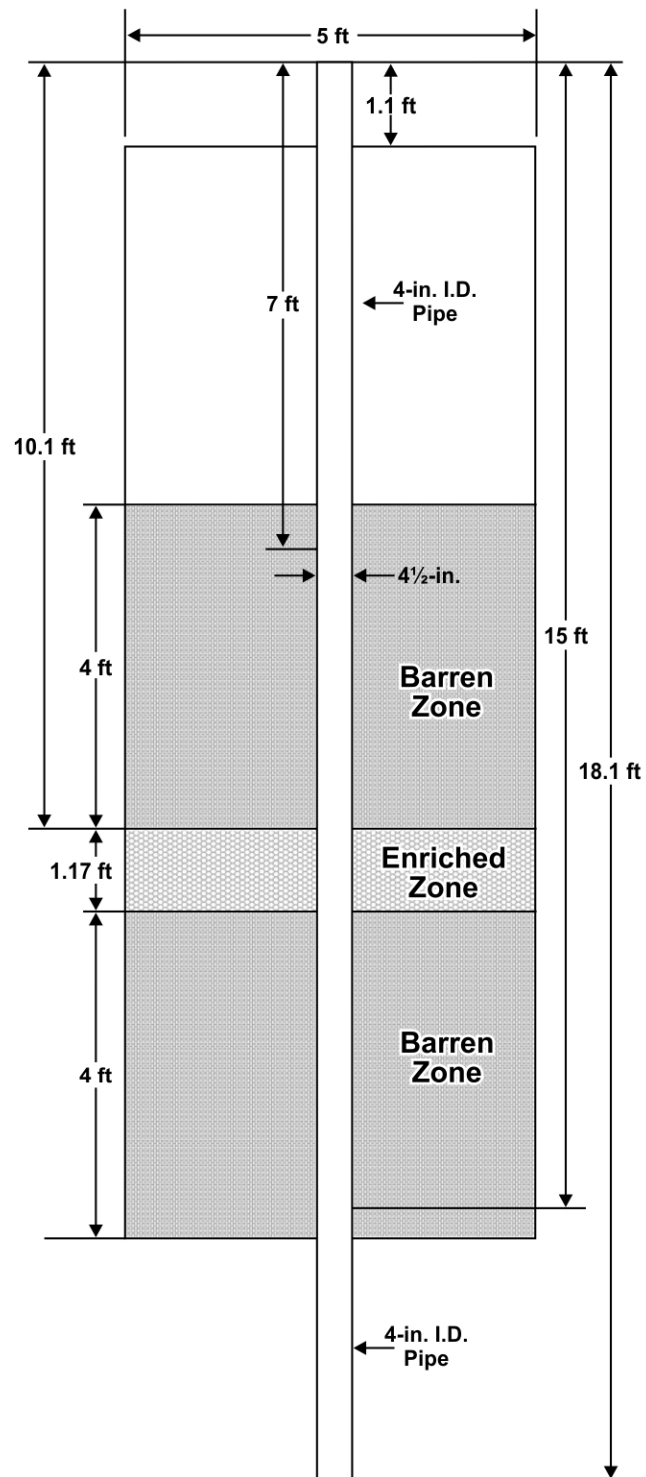

Dimensions shown are for reference only; complete as-built dimensions are not available

Grand Junction N1 Model

Grand Junction N2 Model

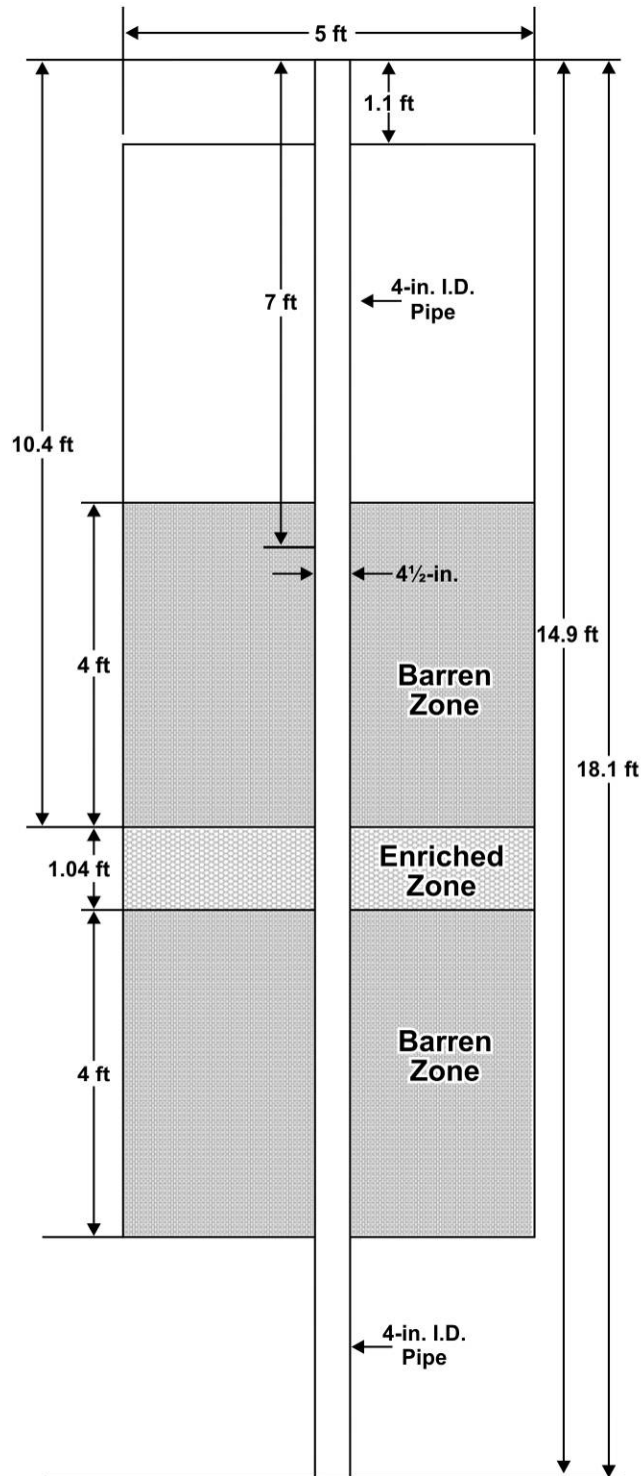

Dimensions shown are for reference only; complete as-built dimensions are not available

Grand Junction N2 Model

Grand Junction N4 Model

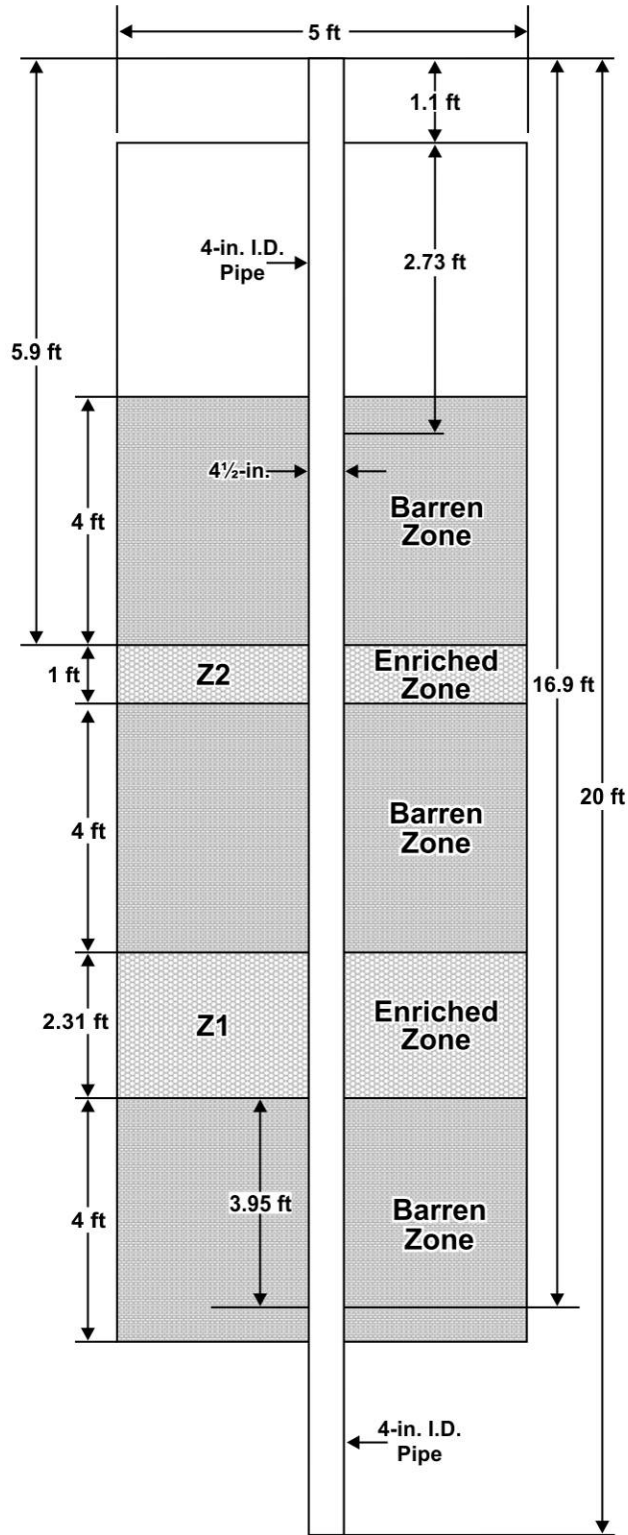

Dimensions shown are for reference only; complete as-built dimensions are not available

Grand Junction N4 Model

Grand Junction N5 Model

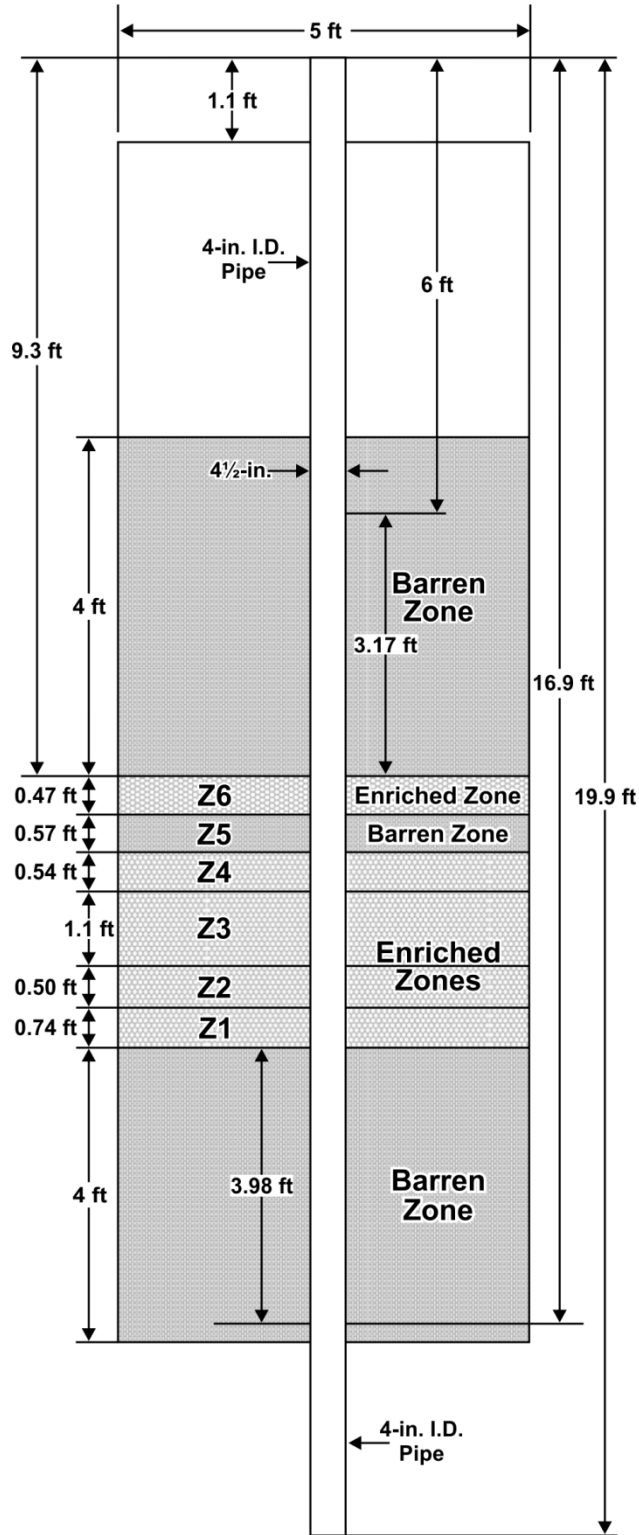

Dimensions shown are for reference only; complete as-built dimensions are not available

Grand Junction N5 Model

Table A-10. Assigned Parameters^a

Model Designation	Zone	Ra-226 Concentration (pCi/g) ^{b,c}	Uranium Concentration (U ppm) ^{b,c}	Thickness (inches) ^c
N1	Enriched	702	1,642	14.0
N2	Enriched	1,216	3,218	12.5
N3	Enriched	654	1,573	50.3
N4	Z1 Enriched	696	1,628	27.8
N4	Z2 Enriched	2,599	7,527	12.0
N5	Z1 Enriched	708	1,662	8.9 ^d
N5	Z2 Enriched	291	712	6.0 ^d
N5	Z3 Enriched	2,678	7,714	13.2
N5	Z4 Enriched	620	1,454	6.5
N5	Z5 Barren ^d	—	—	6.8
N5	Z6 Enriched ^d	4,852	13,830	5.6

^a Values for dry bulk density have not been determined.

^b Assigned values, except for N3 Ra-226 concentration and thickness taken from George et al. (1983), are calculated using conversion factors in Appendix C and values taken from an internal report by Matthews (1975). The values reported were determined by “gamma-only” and chemical analyses on samples taken from the model during its construction.

^c Uncertainties of the values have not been determined.

^d Data for four zones in N5 are based on analysis of logging data published by Bristow et al. (1984), data which was subsequently substantiated by researchers at the GJO.

Grand Junction A Models

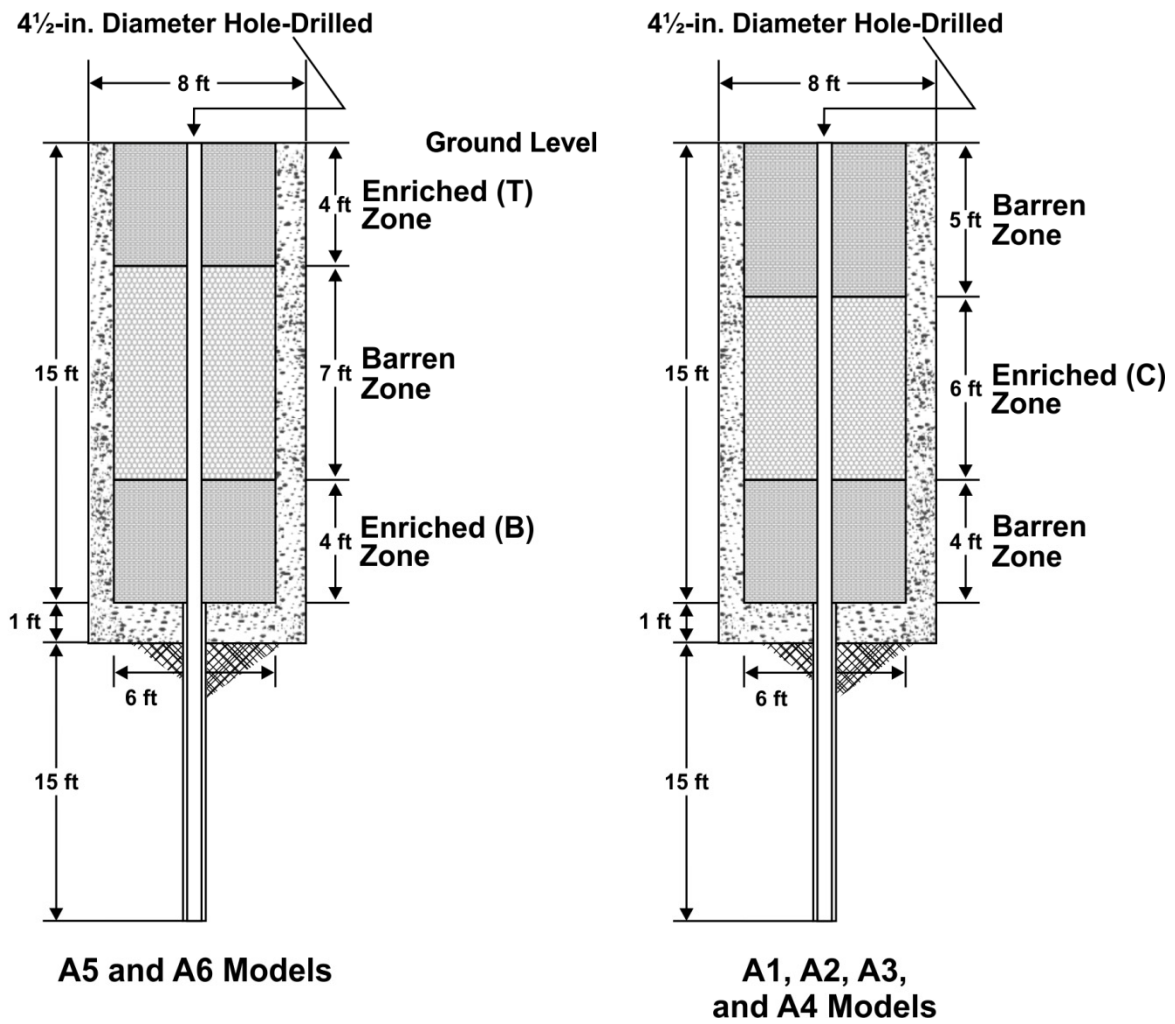

Grand Junction A Models

Table A-11. Assigned Parameters for Calibration of Fission-Neutron Logging Systems^a

Model Designation	Zone	Zone Thickness (ft) ^b	Characteristic ^c	Concentration (pCi/g) ^a			Dry Bulk Density (g/cm ³) ^d	Partial Density H ₂ O (g/cm ³) ^d	Grain Density (g/cm ³) ^d	Porosity (%) ^d	Magnetic Susceptibility (10 ⁻⁶ cgs) ^d
				Ra-226	Th-232	K-40					
A1	C	6.01 ± 0.00 ^e	–	86.3 ± 2.5 ^e	0.73 ± 0.15	15.0 ± 3.0	2.22	0.184 ^e	–	18 ^f	841
A2	C	5.94 ± 0.00 ^e	–	224.7 ± 6.5 ^e	1.04 ± 0.35	18.2 ± 4.2	2.17	0.200 ^e	–	18 ^f	804
A3	C	5.95 ± 0.00 ^e	–	455.8 ± 13.3 ^e	0.73 ± 0.33	15.5 ± 2.2	2.18	0.195 ^e	–	18 ^f	822
A4	C	6	–	600.5 ± 270.1	0.92 ± 0.37	17.8 ± 8.4	2.22	–	–	18 ^f	844
A5	T	4	High Σ	204.6 ± 20.8	1.16 ± 0.31	20.1 ± 8.4	2.17	–	2.64	17.8	741
A5	B	4	High ρ	208.6 ± 6.5	0.86 ± 0.22	19.6 ± 4.2	2.40	–	2.92	17.8	596
A6	T	4	High ø	206.6 ± 7.5	0.78 ± 0.13	13.9 ± 3.5	1.85	–	2.60	28.8	348
A6	C	4	Low ø	201.8 ± 60.0	0.98 ± 0.15	18.8 ± 3.7	2.21	–	2.64	16.3	1,055

^a Uncertainties are 95 percent confidence level. Assigned values taken from Koizumi (1979), except as noted.

^b Uncertainties reported as 0.00 are not zero, but are less than 0.005 ft.

^c Σ = macroscopic neutron cross section; ρ = density; ø = porosity.

^d Uncertainties for these values have not been determined.

^e Assigned values taken from George et al. (1983).

^f Estimated.

Grand Junction D Model

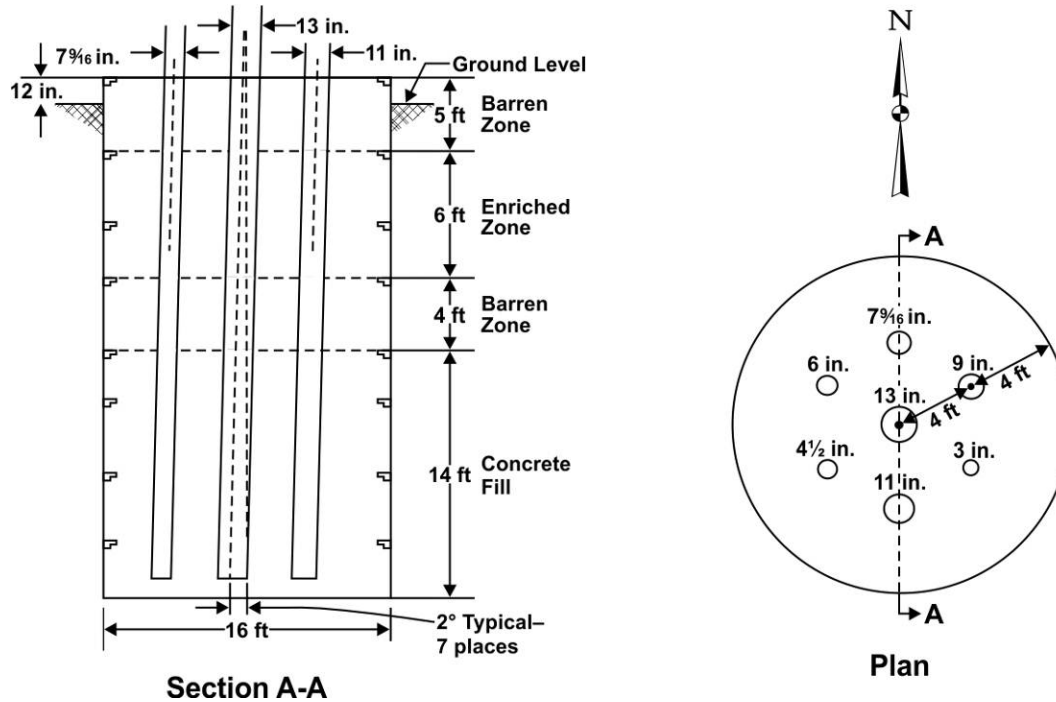

Grand Junction D Model

Table A-12. Assigned Parameters for Calibration of Fission-Neutron Logging Systems^a

Model Designation	Zone	Zone Thickness (ft) ^b	Concentration (pCi/g)			Dry Bulk Density (g/cm ³)	Partial Density H ₂ O (g/cm ³) ^b	Grain Density (g/cm ³)	Porosity (%)	Magnetic Susceptibility (10 ⁻⁶ cgs)
			Ra-226 ^b	Th-232	K-40					
D	Enriched	5.80 ± 0.00 ^c	218 ± 7	0.84 ± 0.37	14.9 ± 4.4	2.12 ± 0.06	0.216	2.72 ± 0.14	22.1 ± 0.2	826 ± 94

^a Uncertainties are 95 percent confidence level. Assigned values taken from Koizumi (1979), except as noted.

^b Assigned value taken from George et al. (1983).

^c Uncertainties reported as 0.00 are not zero, but are less than 0.005 ft.

Grand Junction SW Model

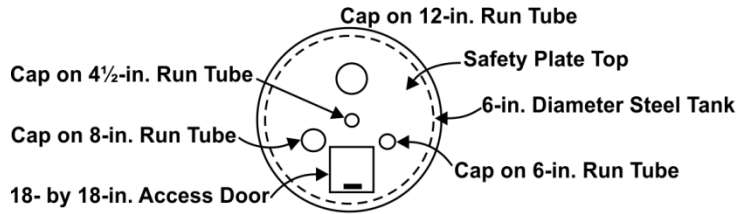

All run tubes are aluminum with .060 in. wall thickness

Plan

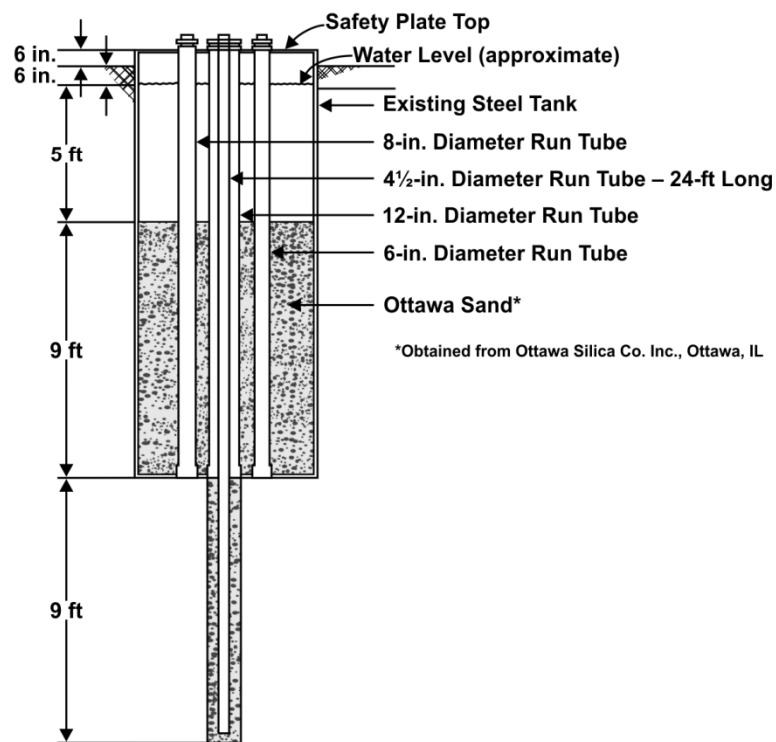

Section

Grand Junction SW Model

Table A-13. Assigned Parameters^a

Zone Designation	Zone Description	Porosity (vol %) ^b	Dry Bulk Density (g/cm ³) ^b	Wet Bulk Density (g/cm ³) ^b	Grain Density (g/cm ³) ^b	Moisture Fraction (wt %) ^b
W	Water	0	—	1.0	—	100
WS	Ottawa Sand	36.0	1.60	1.96	2.50	18.4

^a Assigned values taken from George (1986).

^b Uncertainties for these values have not been determined.

Grand Junction SS/SB Model

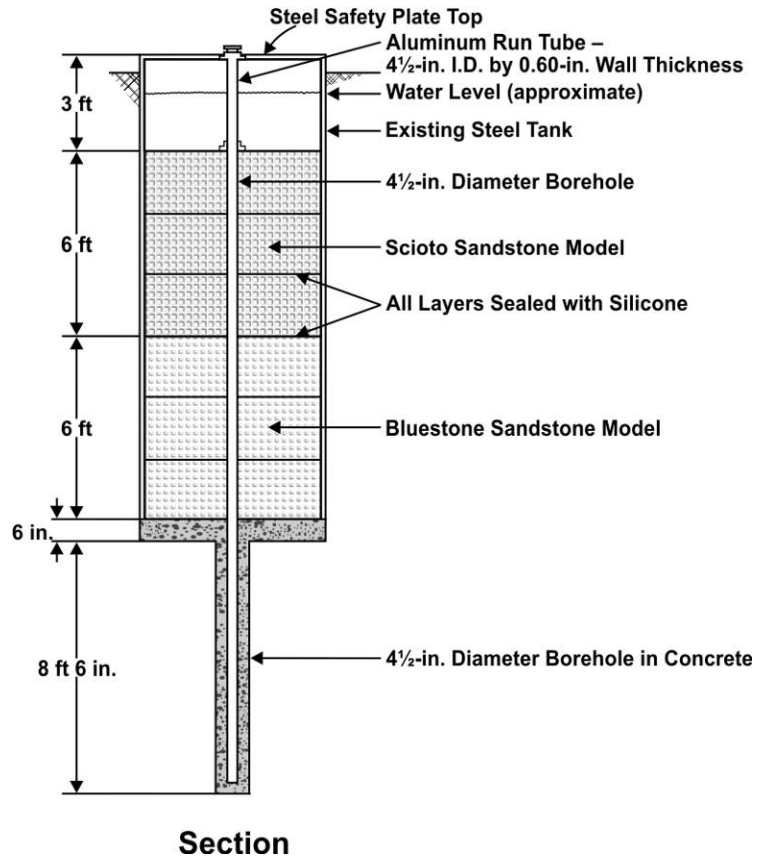
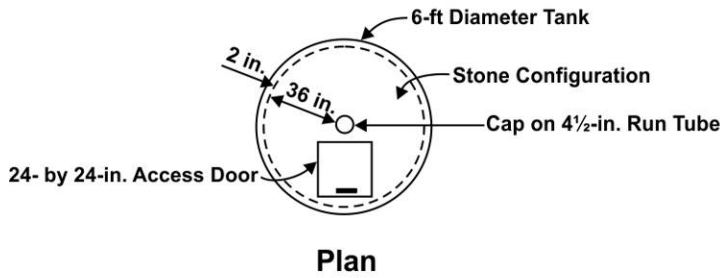

Grand Junction SS/SB Model

Table A-14. Assigned Parameters^a

Zone Designation	Zone Description	Porosity (vol %) ^b	Dry Bulk Density (g/cm ³) ^b	Wet Bulk Density (g/cm ³) ^b	Grain Density (g/cm ³) ^b	Moisture Fraction (wt %) ^{b,c}
SS	Scioto Sandstone	18.3	2.20	2.38	2.69	7.7
SB	Bluestone Sandstone	5.1	2.60	2.65	2.74	1.9

^a Assigned values taken from George (1986).

^b Uncertainties for these values have not been determined.

^c 100 percent saturation is assumed.

This page intentionally left blank

Appendix B

Secondary Field Calibration Facilities

This page intentionally left blank

Secondary Field Calibration Facilities

This appendix presents detailed information concerning layout, locations, pad and model descriptions, and radioelement concentrations for secondary field calibration facilities. These facilities are administered by the U.S. Department of Energy Office of Legacy Management, Grand Junction, Colorado.

Questions concerning the use of the facilities should be addressed to:

Calibration Facilities
2597 Legacy Way
Grand Junction, CO 81503
Phone: (970) 248-6000
Fax: (970) 248-6040

Map to Casper, WY, Calibration Site

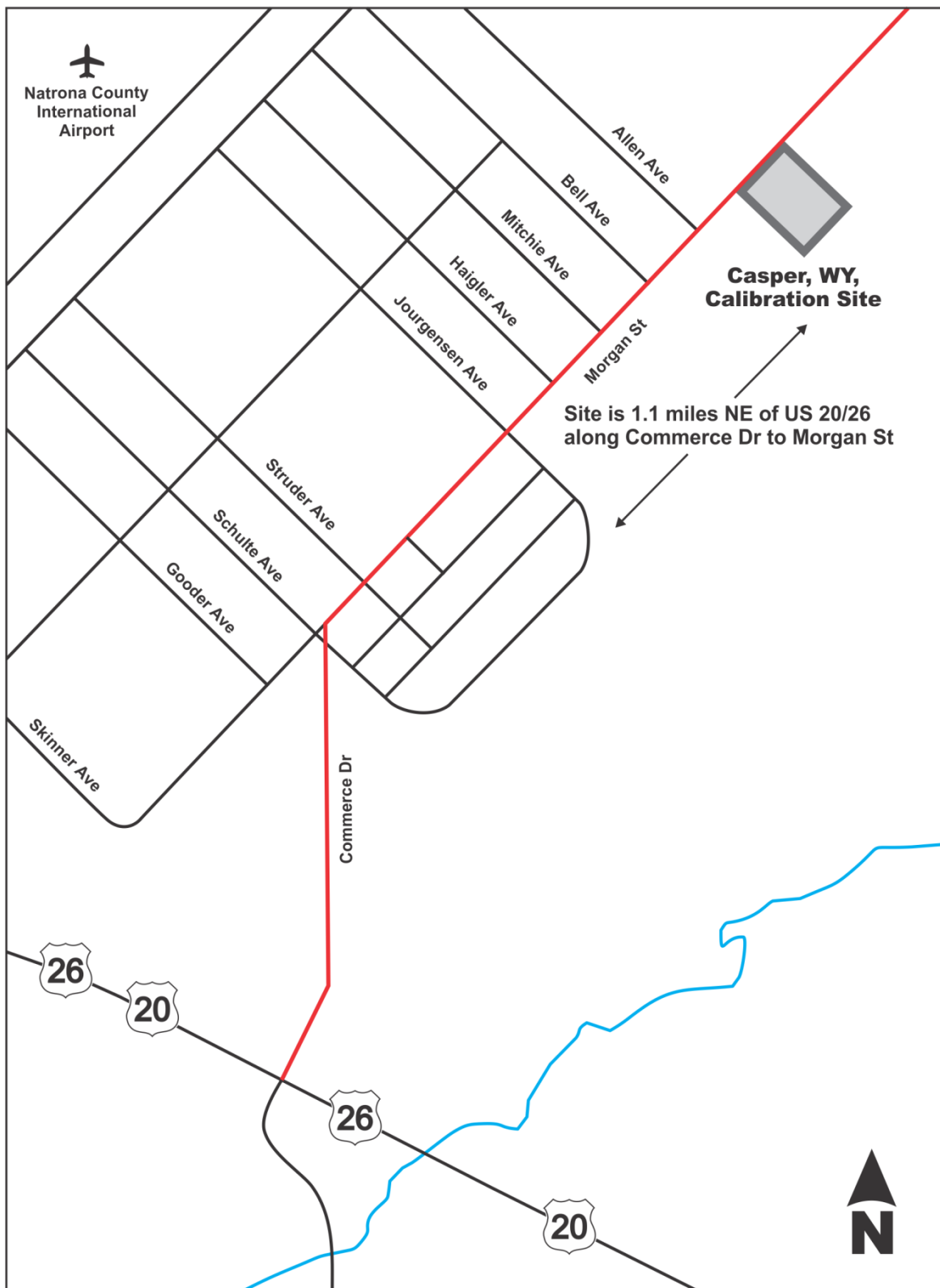

Map to Casper, Wyoming, Calibration Site

Layout of Casper Calibration Site

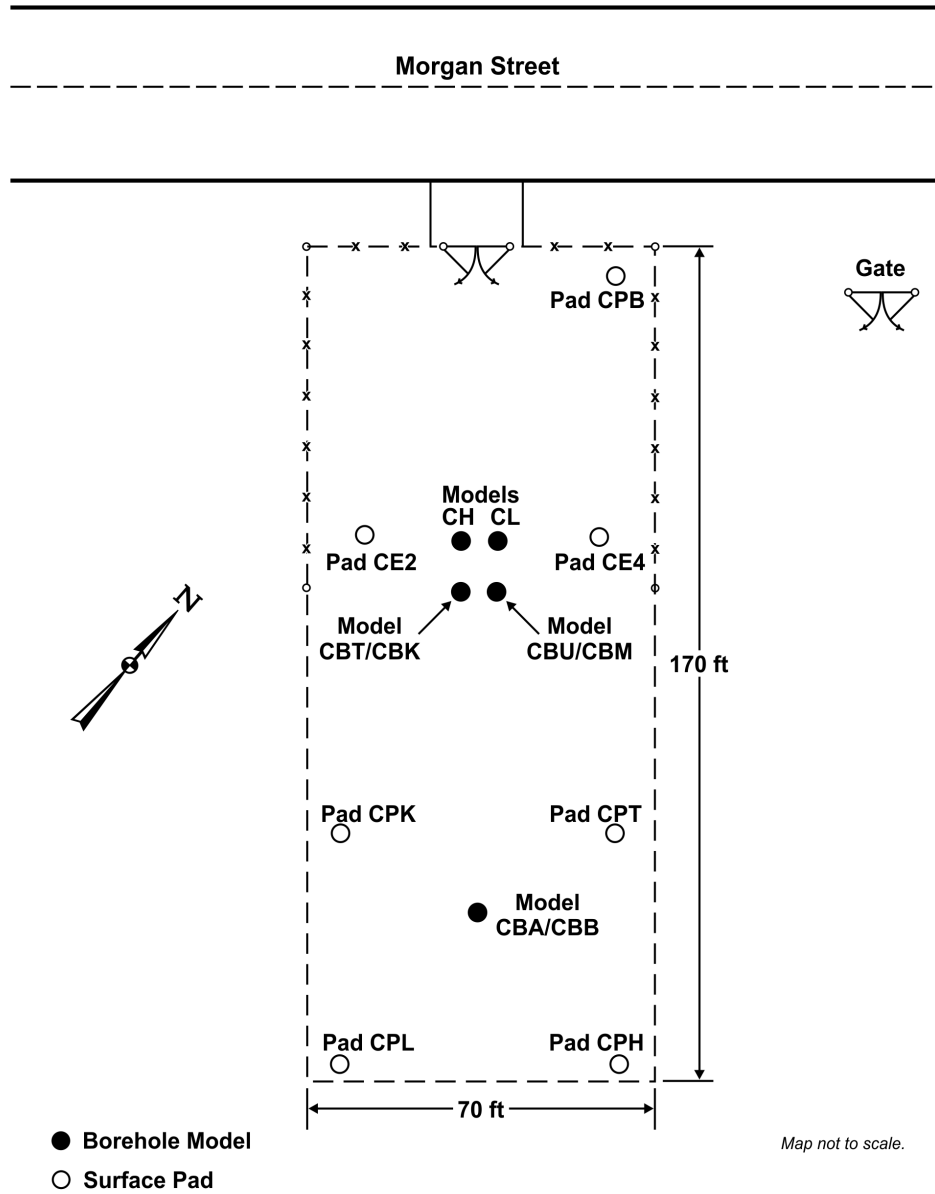

Layout of Casper Calibration Site

Casper P Pads

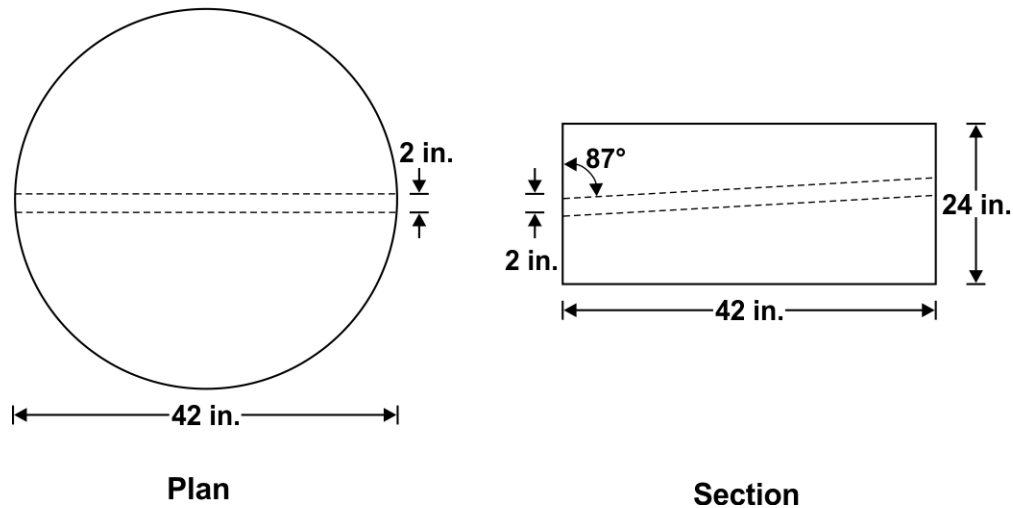

Casper P Pads

Table B-1. Assigned Parameters

Pad Designation	Concentration (pCi/g) ^a			Dry Bulk Density (g/cm ³) ^b	Partial Density H ₂ O (g/cm ³) ^b
	Ra-226	Th-232	K-40		
CPK	0.76 ± 0.90	0.04 ± 0.06	51.36 ± 1.46	1.94	0.130
CPL	91.77 ± 15.20	0.54 ± 0.10	15.44 ± 1.02	1.89	0.148
CPH	360.65 ± 43.82	0.55 ± 0.10	14.99 ± 1.58	1.91	0.153
CPT	6.07 ± 2.92	30.18 ± 0.78	14.13 ± 1.02	1.89	0.157
CPB ^c	0.0 ± 0.3	0.0 ± 0.3	0.0 ± 0.1	—	—

^a Uncertainties are 95 percent confidence level. Assigned values taken from George et al. (1985).

^b Uncertainties for these values have not been determined.

^c Pad does not have a hole as shown above.

Casper E Pads

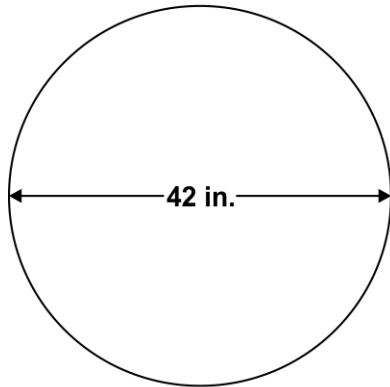

Plan

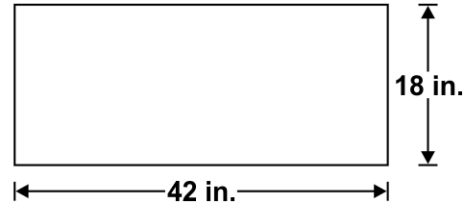

Section

Casper E Pads

Table B-2. Assigned Parameters

Pad Designation	Concentration (pCi/g) ^a			Dry Bulk Density (g/cm ³) ^b	Partial Density H ₂ O (g/cm ³) ^b
	Ra-226	Th-232	K-40		
CE2	81.45 ± 14.42	0.79 ± 0.12	13.63 ± 0.98	1.85	0.135
CE4	409.93 ± 50.90	0.66 ± 0.10	12.29 ± 1.58	1.84	0.162

^a Uncertainties are 95 percent confidence level. Assigned values taken from George et al. (1985).

^b Uncertainties for these values have not been determined.

Casper CBT/CBK, CBU/CBM, and CBA/CBB Models

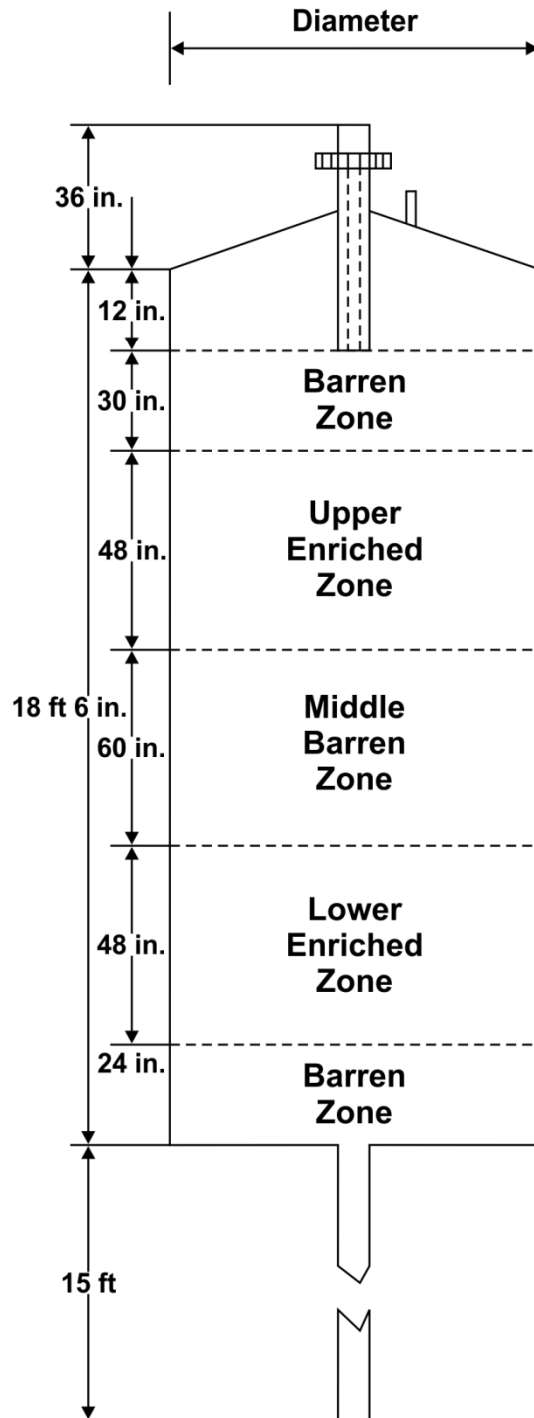

Diameter	
Model	Diameter (in.)
CBT/CBK	48
CBU/CBM	48
CBA/CBB	60

Casper CBT/CBK, CBU/CBM, and CBA/CBB Models

Table B-3. Assigned Parameters for Calibration of Total-Count Gamma-Ray Logging Systems

Model Designation	Zone	Ra-226 Concentration (pCi/g) ^a	Thickness (ft) ^b	Dry Bulk Density (g/cm ³) ^c	Partial Density H ₂ O (g/cm ³) ^c
CBU	Upper	169 ± 6	3.99 ± 0.02	1.91	0.244
CBA	Upper	64.8 ± 1.9	4.00 ± 0.00	2.23	0.189
CBB	Lower	862 ± 26	4.02 ± 0.02	2.21	0.201

^a Uncertainties are 95 percent confidence level. Assigned values taken from George et al. (1983).

^b Uncertainties reported as 0.00 are not zero, but are less than 0.005 ft.

^c Uncertainties for these values have not been determined.

Table B-4. Assigned Parameters for Calibration of Spectral Gamma-Ray Logging Systems

Model Designation	Zone	Concentration (pCi/g) ^a			Dry Bulk Density (g/cm ³) ^b	Partial Density H ₂ O (g/cm ³) ^b
		Ra-226	Th-232	K-40		
CBT	Upper	11.43 ± 0.56	68.46 ± 1.81	10.55 ± 2.01	1.91	0.238
CBK	Lower	1.16 ± 0.10	0.11 ± 0.02	51.21 ± 1.67	1.81	0.255
CBU	Upper	175.94 ± 5.61	0.69 ± 0.06	11.55 ± 0.84	1.91	0.239
CBM	Lower	128.13 ± 4.07	47.73 ± 1.29	41.27 ± 1.84	1.88	0.252

^a Uncertainties are 95 percent confidence level. Assigned values taken from Heistand and Novak (1984).

^b Uncertainties for these values have not been determined.

Table B-5. Assigned Parameters for Calibration of Fission-Neutron Logging Systems

Model Designation	Zone	Ra-226 Concentration (pCi/g) ^a	Thickness (ft) ^b	Dry Bulk Density (g/cm ³) ^c	Partial Density H ₂ O (g/cm ³) ^c
CBA	Upper	64.8 ± 1.9	4.00 ± 0.00	2.23	0.189
CBB	Lower	862 ± 26	4.02 ± 0.02	2.21	0.201

^a Uncertainties are 95 percent confidence level. Assigned values taken from George et al. (1983).

^b Uncertainties reported as 0.00 are not zero, but are less than 0.005 ft.

^c Uncertainties for these values have not been determined.

Casper CH and CL Models

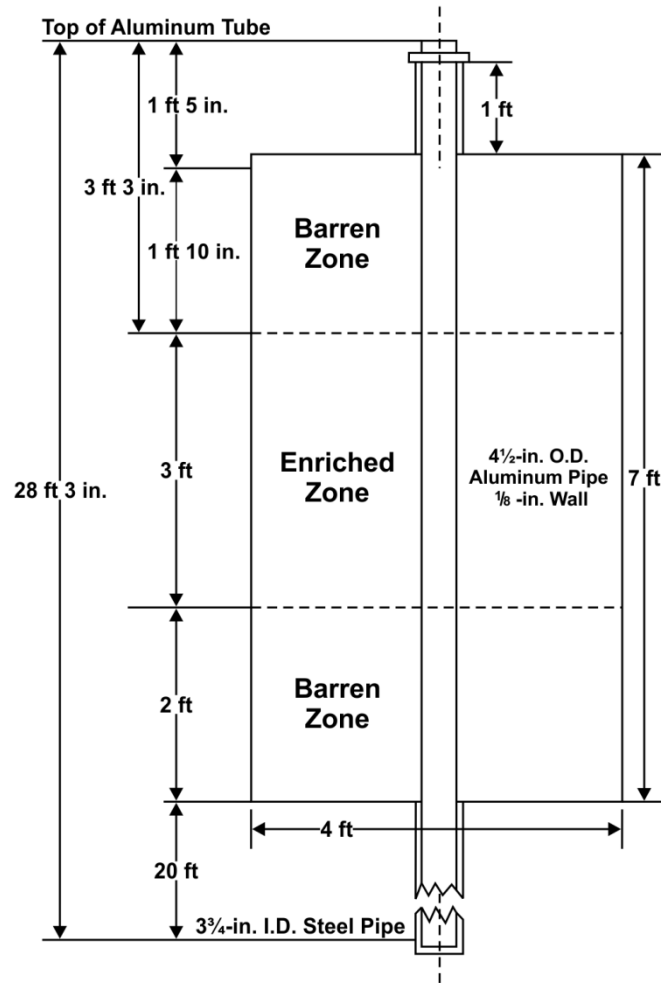

Typical Section
Each Model

Casper CH and CL Models

Table B-6. Assigned Parameters for Calibration of Total-Count Gamma-Ray Logging Systems

Model Designation	Zone	Ra-226 Concentration (pCi/g) ^a	Thickness (ft) ^b	Dry Bulk Density (g/cm ³) ^c	Partial Density H ₂ O (g/cm ³) ^c
CH	Enriched	6,635 ± 388	2.89 ± 0.00	2.21	0.235
CL	Enriched	852 ± 26	2.97 ± 0.00	2.27	0.217

^a Uncertainties are 95 percent confidence level. Assigned values taken from George et al. (1983).

^b Uncertainties reported as 0.00 are not zero, but are less than 0.005 ft.

^c Uncertainties for these values have not been determined.

Map to Grants, NM, Calibration Site

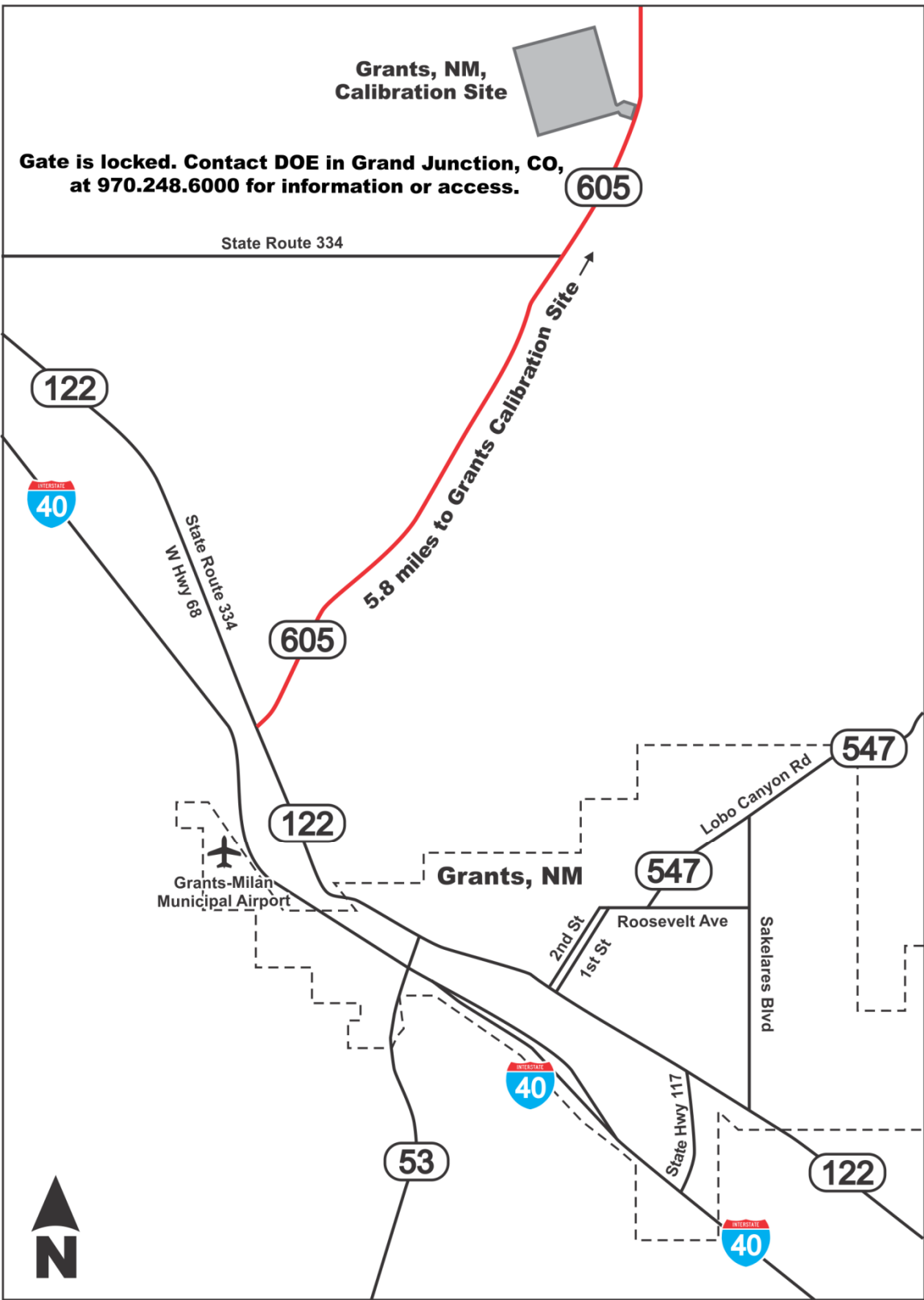

Map to Grants, New Mexico, Calibration Site

Layout of Grants Calibration Site

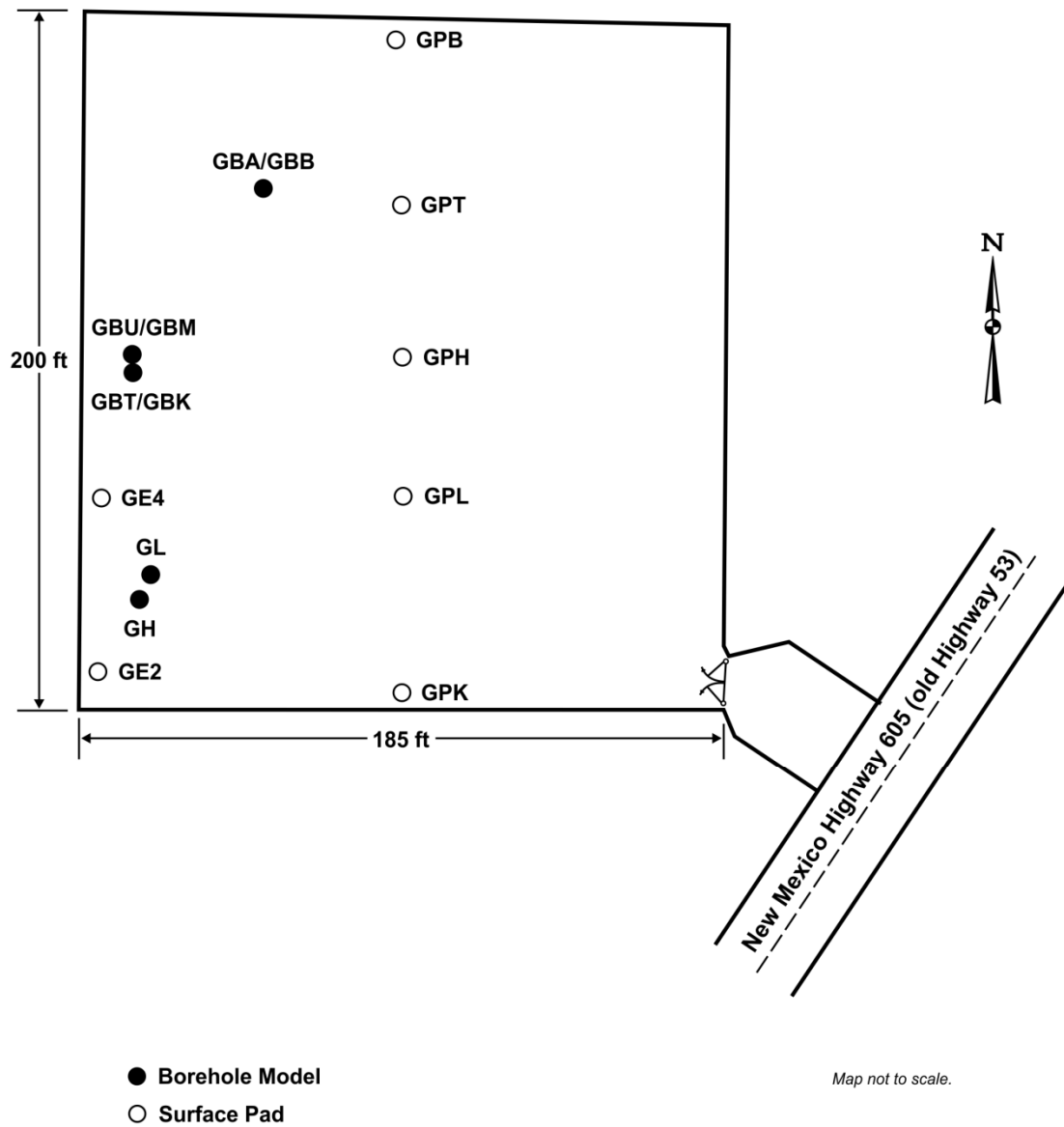

Layout of Grants Calibration Site

Grants P Pads

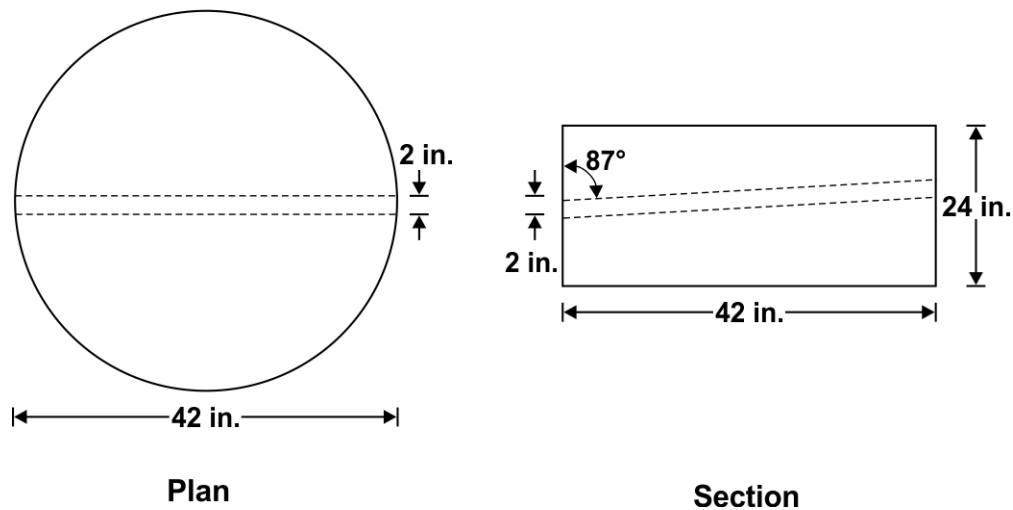

Grants P Pads

Table B-7. Assigned Parameters

Pad Designation	Concentration (pCi/g) ^a			Dry Bulk Density (g/cm ³) ^b	Partial Density H ₂ O (g/cm ³) ^b
	Ra-226	Th-232	K-40		
GPK	0.58 ± 0.82	0.01 ± 0.06	51.53 ± 1.46	1.96	0.127
GPL	87.78 ± 14.32	0.50 ± 0.10	15.58 ± 1.02	1.90	0.165
GPH	375.74 ± 45.14	0.61 ± 0.10	15.93 ± 1.62	1.91	0.142
GPT	6.57 ± 3.14	30.23 ± 0.80	14.94 ± 1.02	1.89	0.146
GPB ^c	0.0 ± 0.3	0.0 ± 0.3	0.0 ± 0.1	—	—

^a Uncertainties are 95 percent confidence level. Assigned values taken from George et al. (1985).

^b Uncertainties for these values have not been determined.

^c Pad does not have a hole as shown above.

Grants E Pads

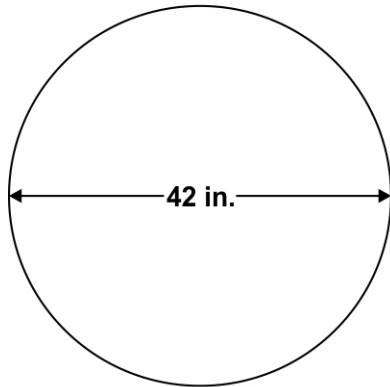

Plan

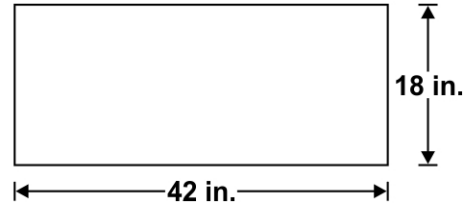

Section

Grants E Pads

Table B-8. Assigned Parameters

Pad Designation	Concentration (pCi/g) ^a			Dry Bulk Density (g/cm ³) ^b	Partial Density H ₂ O (g/cm ³) ^b
	Ra-226	Th-232	K-40		
GE2	83.13 ± 15.42	0.70 ± 0.10	12.93 ± 1.02	1.85	0.237
GE4	396.66 ± 49.70	0.80 ± 0.12	12.20 ± 1.48	1.84	0.148

^a Uncertainties are 95 percent confidence level. Assigned values taken from George et al. (1985).

^b Uncertainties for these values have not been determined.

Grants GBT/GBK,GBU/GBM, and GBA/GBB Models

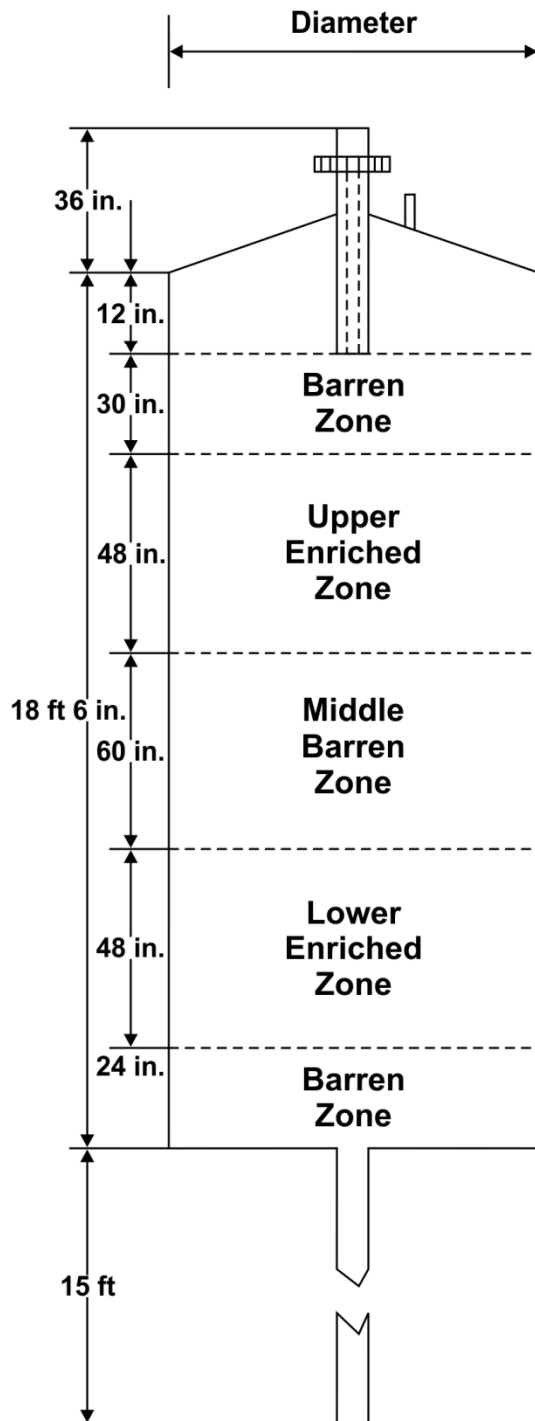

Diameter	
Model	Diameter (in.)
GBT/GBK	48
GBU/GBM	48
GBA/GBB	60

Grants GBT/GBK, GBU/GBM, and GBA/GBB Models

Table B-9. Assigned Parameters for Calibration of Total-Count Gamma-Ray Logging Systems

Model Designation	Zone	Ra-226 Concentration (pCi/g) ^a	Thickness (ft) ^b	Dry Bulk Density (g/cm ³) ^c	Partial Density H ₂ O (g/cm ³) ^c
GBU	Upper	167 ± 5	3.98 ± 0.00	1.88	0.247
GBA	Upper	64.8 ± 1.9	3.97 ± 0.02	2.21	0.189
GBB	Lower	881 ± 27	3.99 ± 0.00	2.22	0.199

^a Uncertainties are 95 percent confidence level. Assigned values taken from George et al. (1983).

^b Uncertainties reported as 0.00 are not zero, but are less than 0.01 ft.

^c Uncertainties for these values have not been determined.

Table B-10. Assigned Parameters for Calibration of Spectral Gamma-Ray Logging Systems

Model Designation	Zone	Concentration (pCi/g) ^a			Dry Bulk Density (g/cm ³) ^b	Partial Density H ₂ O (g/cm ³) ^b
		Ra-226	Th-232	K-40		
GBT	Upper	11.34 ± 0.58	68.06 ± 1.83	9.71 ± 1.51	1.93	0.248
GBK	Lower	1.08 ± 0.10	0.10 ± 0.02	52.16 ± 1.84	1.81	0.263
GBU	Upper	178.18 ± 5.47	0.71 ± 0.06	11.80 ± 0.84	1.88	0.244
GBM	Lower	129.09 ± 4.14	48.22 ± 1.35	41.84 ± 2.01	1.87	0.257

^a Uncertainties are 95 percent confidence level. Assigned values taken from Heistand and Novak (1984).

^b Uncertainties for these values have not been determined.

Table B-11. Assigned Parameters for Calibration of Fission-Neutron Logging Systems

Model Designation	Zone	Ra-226 Concentration (pCi/g) ^a	Thickness (ft) ^b	Dry Bulk Density (g/cm ³) ^c	Partial Density H ₂ O (g/cm ³) ^c
GBA	Upper	64.8 ± 1.9	3.97 ± 0.02	2.21	0.189
GBB	Lower	881 ± 27	3.99 ± 0.00	2.22	0.199

^a Uncertainties are 95 percent confidence level. Assigned values taken from George et al. (1983).

^b Uncertainties reported as 0.00 are not zero, but are less than 0.01 ft.

^c Uncertainties for these values have not been determined.

Grants GH and GL Models

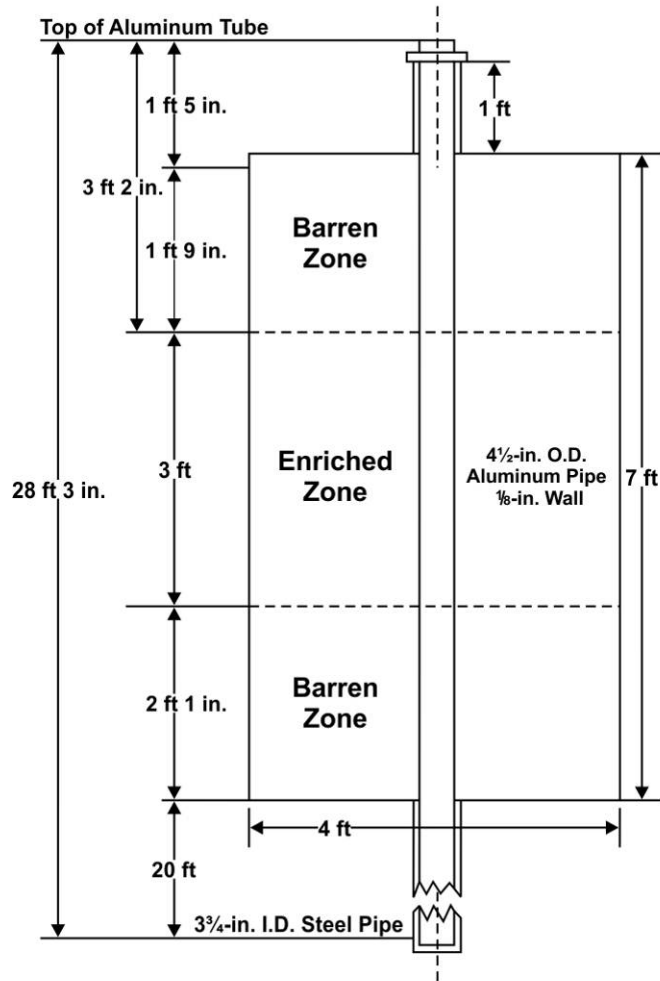

Typical Section
Each Model

Grants GH and GL Models

Table B-12. Assigned Parameters for Calibration of Total-Count Gamma-Ray Logging Systems

Model Designation	Zone	Ra-226 Concentration (pCi/g) ^a	Thickness (ft) ^b	Dry Bulk Density (g/cm ³) ^c	Partial Density H ₂ O (g/cm ³) ^c
GH	Enriched	5,645 ± 344	2.89 ± 0.02	2.22	0.247
GL	Enriched	777 ± 24	2.99 ± 0.00	2.22	0.236

^a Uncertainties are 95 percent confidence level. Assigned values taken from George et al. (1983).

^b Uncertainties reported as 0.00 are not zero, but are less than 0.005 ft.

^c Uncertainties for these values have not been determined.

Map to George West, TX, Calibration Site

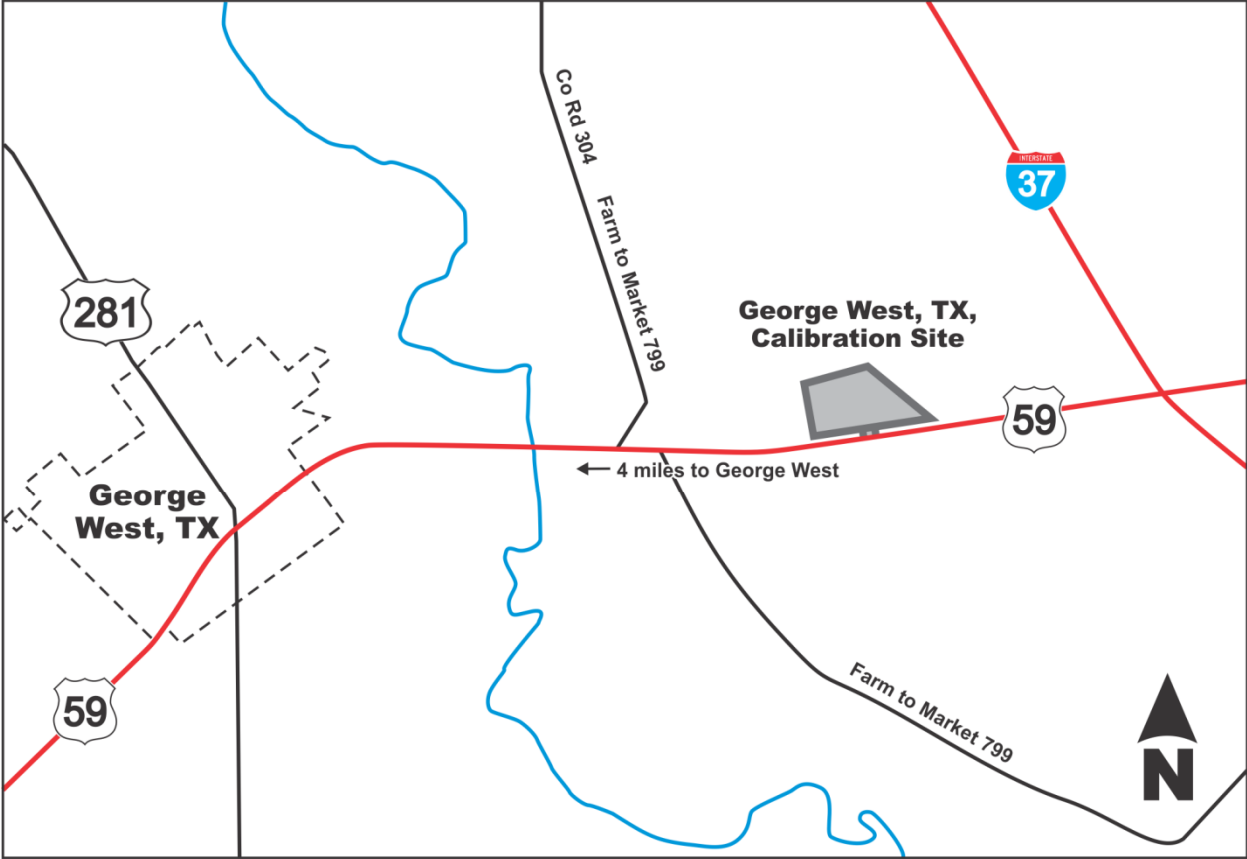

**Gate is locked. Contact DOE in Grand Junction, CO,
at 970.248.6000 for information or access.**

Map to George West, Texas, Calibration Site

Layout of George West Calibration Site

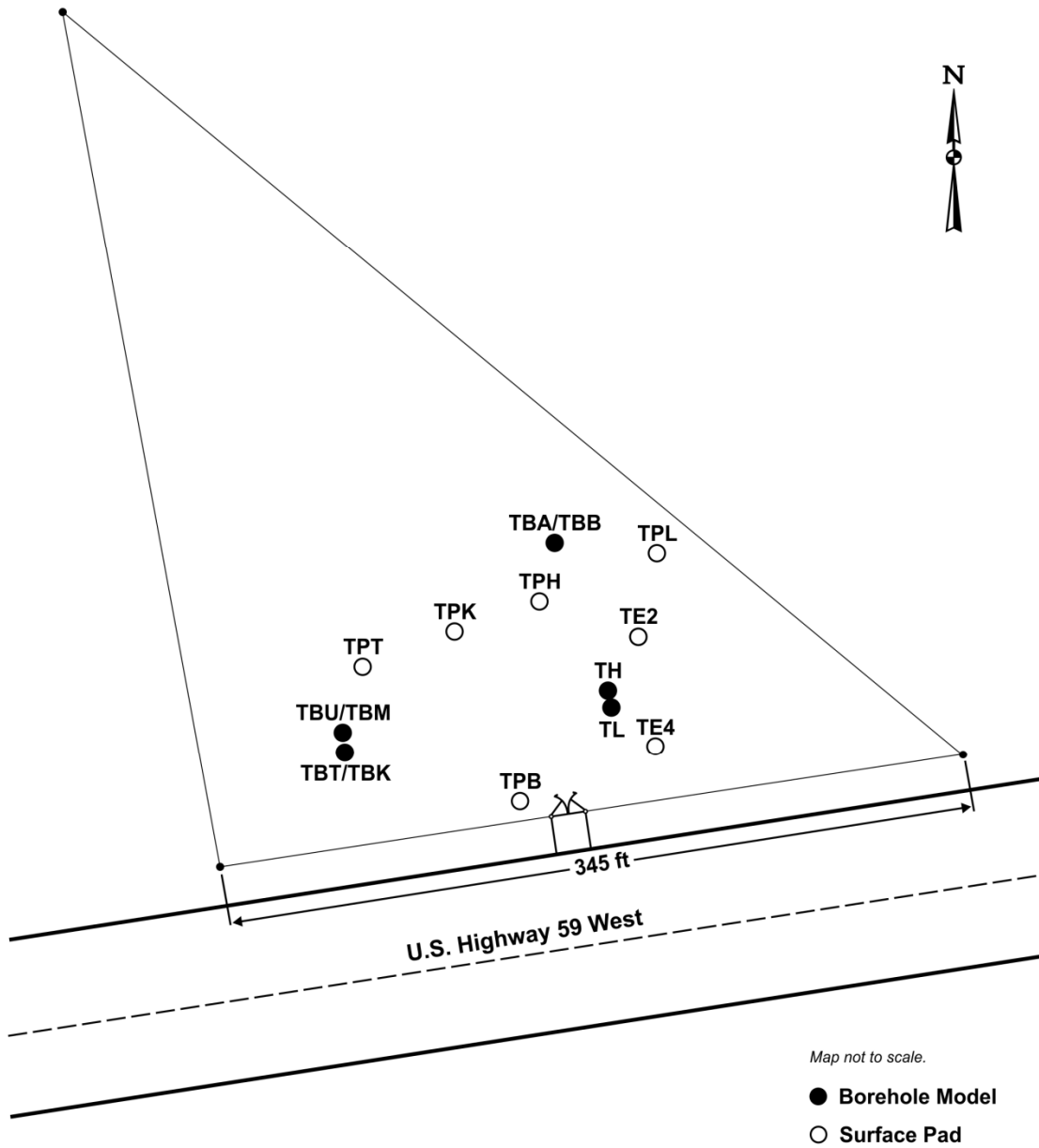

Layout of George West Calibration Site

George West P Pads

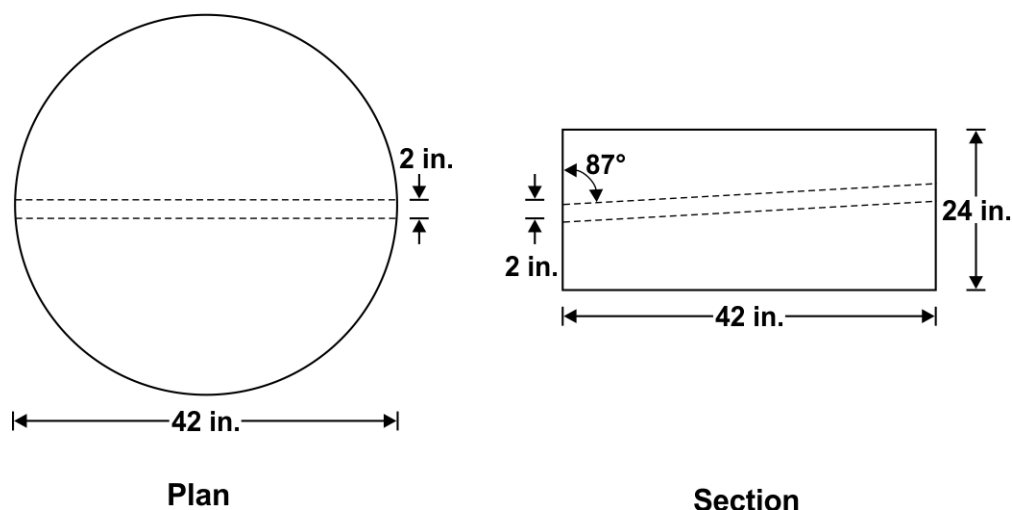

George West P Pads

Table B-13. Assigned Parameters

Pad Designation	Concentration (pCi/g) ^a			Dry Bulk Density (g/cm ³) ^b	Partial Density H ₂ O (g/cm ³) ^b
	Ra-226	Th-232	K-40		
TPK	0.69 ± 0.86	0.00 ± 0.06	52.81 ± 1.46	1.95	0.131
TPL	87.02 ± 14.68	0.57 ± 0.10	15.49 ± 1.02	1.88	0.157
TPH	385.36 ± 47.52	0.45 ± 0.10	14.85 ± 1.42	1.90	0.158
TPT	5.96 ± 2.96	31.21 ± 0.82	15.03 ± 1.08	1.90	0.155
TPB ^c	0.0 ± 0.3	0.0 ± 0.3	0.0 ± 0.1	—	—

^a Uncertainties are 95 percent confidence level. Assigned values taken from George et al. (1985).

^b Uncertainties for these values have not been determined.

^c Pad does not have a hole as shown above.

George West E Pads

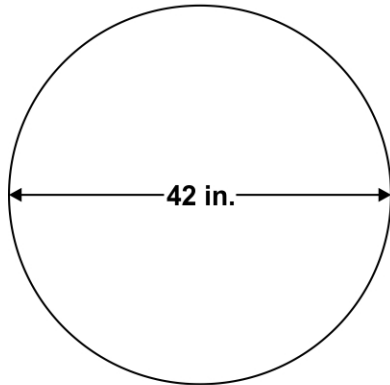

Plan

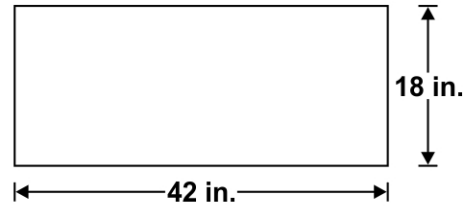

Section

George West E Pads

Table B-14. Assigned Parameters

Pad Designation	Concentration (pCi/g) ^a			Dry Bulk Density (g/cm ³) ^b	Partial Density H ₂ O (g/cm ³) ^b
	Ra-226	Th-232	K-40		
TE2	83.53 ± 15.10	0.66 ± 0.10	13.17 ± 0.98	1.83	0.177
TE4	398.74 ± 50.36	0.51 ± 0.10	11.44 ± 1.58	1.86	0.223

^a Uncertainties are 95 percent confidence level. Assigned values taken from George et al. (1985).

^b Uncertainties for these values have not been determined.

George West TBT/TBK, TBU/TBM, and TBA/TBB Models

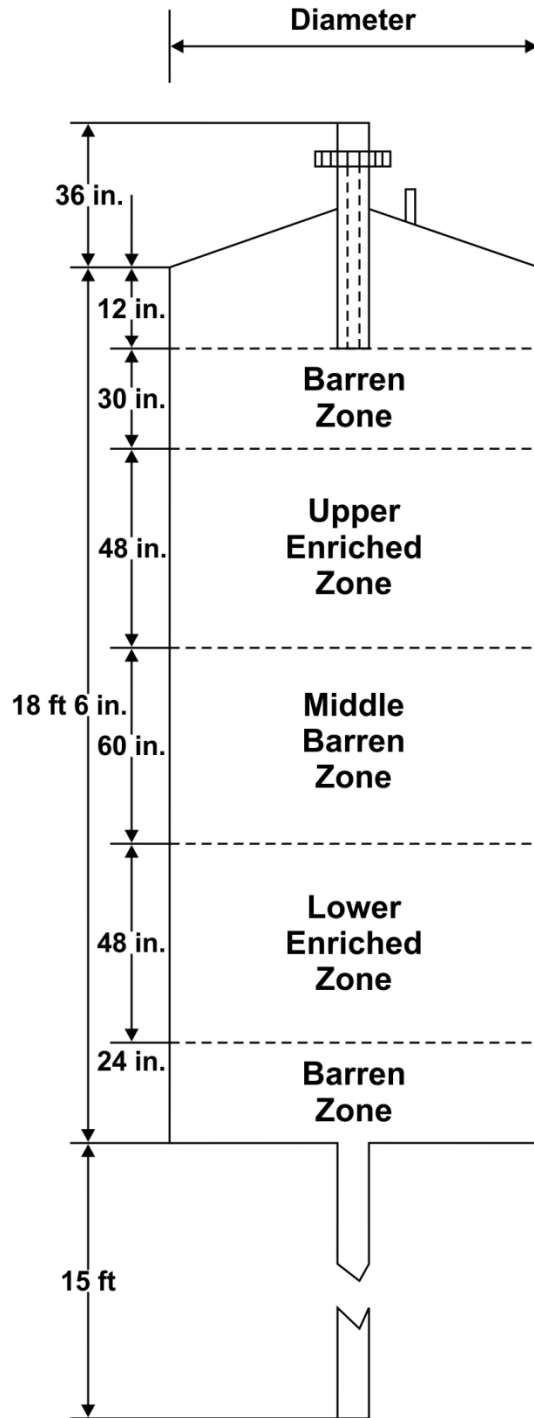

Diameter	
Model	Diameter (in.)
TBT/TBK	48
TBU/TBM	48
TBA/TBB	60

George West TBT/TBK, TBU/TBM, and TBA/TBB Models

Table B-15. Assigned Parameters for Calibration of Total-Count Gamma-Ray Logging Systems

Model Designation	Zone	Ra-226 Concentration (pCi/g) ^a	Thickness (ft) ^b	Dry Bulk Density (g/cm ³) ^c	Partial Density H ₂ O (g/cm ³) ^c
TBU	Upper	168 ± 6	3.98 ± 0.00	1.87	0.247
TBA	Upper	61.8 ± 1.7	3.95 ± 0.02	2.20	0.184
TBB	Lower	840 ± 25	3.96 ± 0.00	2.21	0.187

^a Uncertainties are 95 percent confidence level. Assigned values taken from George et al. (1983).

^b Uncertainties reported as 0.00 are not zero, but are less than 0.01 ft.

^c Uncertainties for these values have not been determined.

Table B-16. Assigned Parameters for Calibration of Spectral Gamma-Ray Logging Systems

Model Designation	Zone	Concentration (pCi/g) ^a			Dry Bulk Density (g/cm ³) ^b	Partial Density H ₂ O (g/cm ³) ^b
		Ra-226	Th-232	K-40		
TBT	Upper	11.30 ± 0.55	67.66 ± 1.88	9.71 ± 1.67	1.94	0.243
TBK	Lower	1.13 ± 0.10	0.09 ± 0.02	53.58 ± 1.84	1.81	0.264
TBU	Upper	177.01 ± 5.54	0.69 ± 0.06	11.39 ± 1.00	1.87	0.247
TBM	Lower	128.63 ± 4.14	48.62 ± 1.40	42.03 ± 2.01	1.85	0.257

^a Uncertainties are 95 percent confidence level. Assigned values taken from Heistand and Novak (1984).

^b Uncertainties for these values have not been determined.

Table B-17. Assigned Parameters for Calibration of Fission-Neutron Logging Systems

Model Designation	Zone	Ra-226 Concentration (pCi/g) ^a	Thickness (ft) ^b	Dry Bulk Density (g/cm ³) ^c	Partial Density H ₂ O (g/cm ³) ^c
TBA	Upper	61.8 ± 1.7	3.95 ± 0.02	2.20	0.184
TBB	Lower	840 ± 25	3.96 ± 0.00	2.21	0.187

^a Uncertainties are 95 percent confidence level. Assigned values taken from George et al. (1983).

^b Uncertainties reported as 0.00 are not zero, but are less than 0.01 ft.

^c Uncertainties for these values have not been determined.

George West TH and TL Models

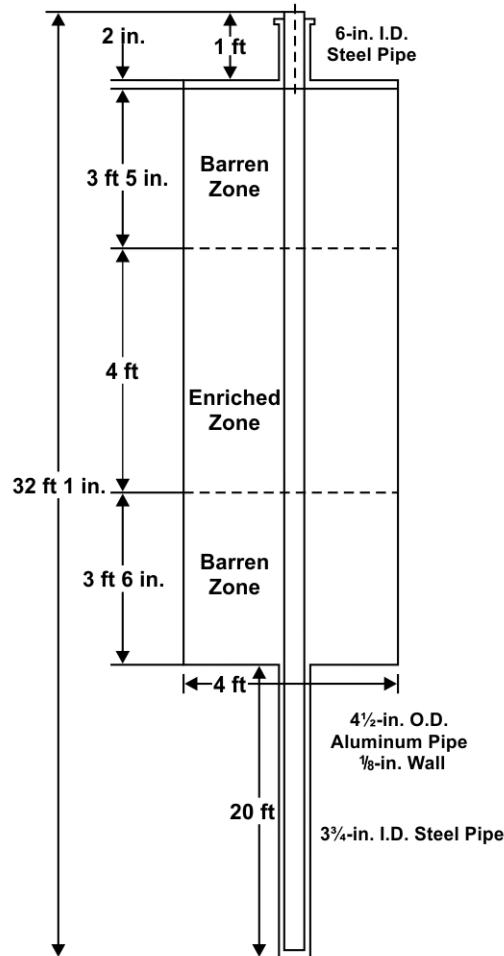

Typical Section

George West TH and TL Models

Table B-18. Assigned Parameters for Calibration of Total-Count Gamma-Ray Logging Systems

Model Designation	Zone	Ra-226 Concentration (pCi/g) ^a	Thickness (ft) ^b	Dry Bulk Density (g/cm ³) ^c	Partial Density H ₂ O (g/cm ³) ^c
TH	Enriched	5,770 ± 368	3.94 ± 0.00	1.86	0.302
TL	Enriched	680 ± 23	3.99 ± 0.00	2.07	0.272

^a Uncertainties are 95 percent confidence level. Assigned values taken from George et al. (1983).

^b Uncertainties reported as 0.00 are not zero, but are less than 0.005 ft.

^c Uncertainties for these values have not been determined.

Appendix C
Conversion Factors

This page intentionally left blank

Conversion Factors

This appendix presents conversion factors used to determine radioelement concentrations for the calibration facilities. An example of conversion-factor derivation is presented in Appendix D. The nuclear data referenced in this appendix are taken from the *Table of Isotopes* (Lederer and Shirley 1978). Half-life (T), isotopic-abundance (P), and gram atomic weight (A) data agree (within quoted significant figures) with those listed in the *Chart of Nuclides* (Walker et al. 1977).

Conversion factors for a sample containing uranium in secular equilibrium with its daughters are:

$$\begin{aligned} 1 \text{ g (eU-238)} &= 3.400 \times 10^{-7} \text{ g (Ra-226)} & 1 \text{ g (eU)} &= 3.376 \times 10^{-7} \text{ g (Ra-226)} \\ 1 \text{ wt-ppm (eU)} &= 0.3337 \text{ pCi (Ra-226)/g} & 1 \text{ pCi (Ra-226)/g} &= 3.534 \times 10^{-4} \text{ wt-\% (eU}_3\text{O}_8\text{)} \\ 1 \text{ pCi (Ra-226)/g} &= 2.997 \text{ wt-ppm (eU)} & 1 \text{ wt-\% (eU}_3\text{O}_8\text{)} &= 2,830 \text{ pCi (Ra-226)/g} \end{aligned}$$

The conversion factor for radium is:

$$\begin{aligned} n_{\text{Ra-226}} &= \text{specific activity of Ra-226} \\ &= N_o \lambda_{\text{Ra-226}}/A_{\text{Ra-226}} \\ &= 0.9885 \text{ Ci/g} \end{aligned}$$

Conversion factors computed for a sample containing thorium are:

$$\begin{aligned} 1 \text{ pCi (Th-232)/g} &= 9.159 \text{ wt-ppm (eTh)} \\ 1 \text{ wt-ppm (eTh)} &= 0.1092 \text{ pCi (Th-232)/g} \end{aligned}$$

Conversion factors computed for a sample containing naturally occurring potassium are

$$\begin{aligned} 0.0117 \text{ atom-\% (K-40)} &= 0.01196 \text{ wt-\% (K-40)} \\ 1 \text{ pCi (K-40)/g} &= 0.1195 \text{ wt-\% (K)} \\ 1 \text{ wt-\% (K)} &= 8.372 \text{ pCi (K-40)/g} \\ 1 \text{ pCi (K-40)/g} &= 1.428 \times 10^{-5} \text{ wt-\% (K-40)} \end{aligned}$$

Numerical values used for computing the conversion factors are:

$$\begin{array}{lll} A_{\text{U-238}} = 238.9597 \text{ g/mole} & P_{\text{U-238}} = 99.275\% & T_{\text{U-238}} = 4.468 \times 10^9 \text{ years} = 1.410 \times 10^{17} \text{ sec} \\ A_{\text{U-235}} = 235.0439 \text{ g/mole} & P_{\text{U-235}} = 0.720\% & T_{\text{Ra-226}} = 1,600 \text{ years} = 5.049 \times 10^{10} \text{ sec} \\ A_{\text{U-234}} = 234.0409 \text{ g/mole} & P_{\text{U-234}} = 0.0054\% & T_{\text{Th-232}} = 1.411 \times 10^{10} \text{ years} = 4.453 \times 10^{17} \text{ sec} \\ A_{\text{Ra-226}} = 226.0254 \text{ g/mole} & P_{\text{Th-232}} = 100\% & T_{\text{K-40}} = 1.278 \times 10^9 \text{ years} = 4.033 \times 10^{16} \text{ sec} \\ A_{\text{Th-232}} = 232.0380 \text{ g/mole} & P_{\text{K-41}} = 6.73\% & N_o = 6.022045 \times 10^{23} \text{ atoms/mole} \\ A_{\text{K-41}} = 40.9618 \text{ g/mole} & P_{\text{K-40}} = 0.0117\% & 1 \text{ Ci} = 3.7 \times 10^{10} \text{ disintegrations/sec} \\ A_{\text{K-40}} = 39.9640 \text{ g/mole} & P_{\text{K-39}} = 93.26\% & \\ A_{\text{K-39}} = 38.9637 \text{ g/mole} & & \end{array}$$

Appendix D

Example Conversion Factor Derivation

This page intentionally left blank

Example Conversion Factor Derivation

The calibration of gamma-ray counting instruments at Grand Junction has been traditionally performed using equivalent uranium (eU) as the reporting unit for spectral instruments and equivalent uranium oxide (eU₃O₈) as the reporting unit for gross-count or total-count instruments. The word equivalent (e) has been traditionally taken to mean radiometric equivalent or gamma-ray equivalent, because concentrations assigned to the calibration models are based on gamma-ray measurements. The purpose of this derivation is to establish the factors needed to convert from currently assigned uranium concentrations in parts per million on a weight basis for eU [wt-ppm(eU)] and in weight percentage for eU₃O₈ [wt-% (eU₃O₈)] to radium concentrations [pCi (Ra-226)/g].

For the conversion derived, it is necessary to assume secular equilibrium between uranium and radium-226 in the uranium decay series. This assumption has always been made in the past when assigning equivalent-uranium concentrations to the models and pads. Because previous assignments are based on gamma-ray counting measurements, and because those measurements are responsive primarily to radium-226 daughters, the assumption is appropriate here.

For a given sample of mass M, containing uranium and its daughters in secular equilibrium, the decay rates of U-238 and Ra-226 are equal by definition. That is,

$$\text{Decay rate} \left(\frac{-dN}{dT} \right) = N_{Ra-226} \lambda_{Ra-226} = N_{U-238} \lambda_{U-238} \quad (1)$$

where

- N = number of atoms of the isotope indicated by the subscript,
- λ = decay constant of the isotope indicated by the subscript,
= $\ln(2)/T$,
- T = half-life of the isotope indicated by the subscript.

If both sides of Equation (1) are divided by the mass of the sample, M, and if mass-normalized decay rate is r,

$$r_{Ra-226} = r_{U-238} = \frac{N_{Ra-226} \lambda_{Ra-226}}{M} = \frac{N_{U-238} \lambda_{U-238}}{M} \quad (2)$$

Computing the number of atoms of U-238 from the mass of U-238 in the sample, M_{U-238},

$$r_{Ra-226} = \frac{N_{U-238} \lambda_{U-238}}{M} = \left(\frac{M_{U-238}}{M} \right) \left(\frac{N_o}{A_{U-238}} \right) \lambda_{U-238} \quad (3)$$

Where

- N_o = Avogadro's number, and
- A = gram atomic weight of the isotope indicated by the subscript.

Noting that M_{U-238}/M is the weight fraction of U-238 in the sample,

$$c_{U-238} = \frac{M_{U-238}}{M} \quad (4)$$

Equation (3) produces the result

$$r_{Ra-226} = c_{U-238} \left(\frac{N_o \lambda_{U-238}}{A_{U-238}} \right) \quad (5)$$

The desired units are picocuries of Ra-226 per gram of sample [pCi(Ra-226)/g], the parts per million on a weight basis for U-238 (wt-ppm). Performing the computation indicated in Equation (5) and converting units produces

$$r_{Ra-226} = \left(\frac{c_{U-238}}{2.975} \right) \quad (6)$$

where r_{Ra-226} is the mass-normalized decay rate of Ra-226 in picocuries per gram and c_{U-238} is the weight concentration of U-238 in parts per million.

Numerical values and conversion factors used for the computations are presented in Appendix C.

The result in Equation (6) must be adjusted to account for the isotopic abundance of U-238 within naturally occurring uranium (U). The isotopic abundance of U-238 must first be computed on a weight basis because the isotopic abundance values in the *Table of Isotopes* (Lederer and Shirley 1978) are given on an atom-percent basis.

$$\begin{aligned} P'_{U-238} &= \frac{P_{U-238} A_{U-238}}{P_{U-238} A_{U-238} + P_{U-235} A_{U-235} + P_{U-234} A_{U-234}} \\ &= 0.9928 \frac{g(U-238)}{g(U)} \end{aligned} \quad (7)$$

where P' is the isotopic abundance on a weight basis for the isotope indicated by the subscript, and P is the isotopic abundance on an atom-percent basis for the isotope indicated by the subscript.

From this result, $c_{U-238} = 0.9928c_U$, which is then substituted into Equation (6) to produce the final and desired result

$$r_{Ra-226} = \left(\frac{c_U}{2.997} \right) \quad (8)$$

where c_U is the weight concentration of naturally occurring uranium in parts per million (ppm) and r_{Ra-226} is the mass-normalized decay rate of Ra-226 in picocuries per gram.

Appendix E

Steel Casing Sections

Steel casings are available at the Grand Junction primary calibration facility to create casing factors. Users must provide their own supporting cables and hoisting equipment.

Grand Junction Calibration Facility Steel casing sections for casing corrections

Steel Thickness	Inner Diameter	Length
1/16 inch	2 15/16 inch	54 inch
1/8 inch	2 15/16 inch	54 inch
3/16 inch	2 15/16 inch	54 inch
¼ inch	2 15/16 inch	54 inch
3/8 inch	2 15/16 inch	54 inch
½ inch	2 15/16 inch	54 inch
Steel Thickness	Inner Diameter	Length
1/16 inch	2 ¼ inch	18 inch
1/8 inch	2 ¼ inch	18 inch
3/16 inch	2 ¼ inch	18 inch
¼ inch	2 ¼ inch	18 inch
3/8 inch	2 ¼ inch	18 inch
3/16 inch	3.0 inch	18 inch
3/8 inch	3.0 inch	18 inch
½ inch	3.0 inch	18 inch
1.0 inch	3.0 inch	36 inch
Steel Thickness	Inner Diameter	Length
¼ inch	6.0 inch	38 ½ inch
3/8 inch	10.0 inch	45 inch
5/16 inch	7 7/8 inch	46 ½ inch
5/8 inch	3 ¾ inch	38 ½ inch

This page intentionally left blank

Appendix F

Enriched-Zone Grades as % ${}^e\text{U}_3\text{O}_8$

Assignments for Logging Models

Model	Location	Primary Use ^a	Enriched-Zone Grade		Enriched-Zone Thickness (ft) ^b	Enriched-Zone Moisture (wt-%) ^c	Dry Bulk Density (g/cc) ^c
			% ${}^e\text{U}_3\text{O}_8$ ^b	ppm ${}^e\text{U}$ ^b			
U1	Grand Junction, Colorado	TC	2.636 ± 0.082	22355 ± 697	4.06 ± 0.01	11.0	2.074
U2		TC	1.229 ± 0.038	10424 ± 326	4.01 ± 0.00	14.8	1.699
U3		TC	0.4516 ± 0.0091	3830 ± 77	4.01 ± 0.00	15.4	1.667
WF		TC	0.3003 ± 0.0053	2547 ± 45	4.02 ± 0.00	13.1	1.86
N3		TC	0.2310 ± 0.0041	1959 ± 35	4.19 ± 0.00	13.3	1.83
D		FN	0.0772 ± 0.0012	654.5 ± 9.8	5.80 ± 0.00	9.3	2.116
U		KUT	0.05569 ± 0.00097	472.3 ± 8.2	4.98 ± 0.00	12.6	1.89
A1		FN	0.03051 ± 0.00044	258.7 ± 3.7	6.01 ± 0.00	7.7	2.22
A2		FN	0.0794 ± 0.0012	673.5 ± 9.8	5.94 ± 0.00	8.4	2.17
A3	FN	0.1611 ± 0.0024	1366 ± 20	5.95 ± 0.00	8.2	2.18	
CRA	Casper, Wyoming	FN	0.02291 ± 0.00033	194.3 ± 2.8	4.00 ± 0.00	7.8	2.23
CBB		FN	0.3047 ± 0.0046	2584 ± 39	4.02 ± 0.01	8.3	2.21
CH		TC	2.345 ± 0.069	19886 ± 581	2.89 ± 0.00	9.6	2.21
CL		TC	0.3009 ± 0.0046	2552 ± 39	2.97 ± 0.00	8.7	2.27
CBU		KUT	0.05970 ± 0.00098	506.3 ± 8.3	3.99 ± 0.01	11.3	1.91
TBA	George West, Texas	FN	0.02184 ± 0.00031	185.2 ± 2.6	3.95 ± 0.01	7.7	2.20
TBB		FN	0.2969 ± 0.0044	2518 ± 37	3.96 ± 0.00	7.8	2.21
TH		TC	2.039 ± 0.065	17292 ± 552	3.94 ± 0.00	13.9	1.86
TL		TC	0.2402 ± 0.0040	2037 ± 34	3.99 ± 0.00	11.6	2.07
TBU		KUT	0.05950 ± 0.00098	504.6 ± 8.3	3.98 ± 0.00	11.7	1.87
GBA	Grants, New Mexico	FN	0.02289 ± 0.00033	194.1 ± 2.8	3.97 ± 0.01	7.9	2.21
GBB		FN	0.3114 ± 0.0047	2641 ± 40	3.99 ± 0.00	8.2	2.22
GH		TC	1.995 ± 0.061	16919 ± 516	2.89 ± 0.01	10.0	2.22
GL		TC	0.2745 ± 0.0042	2328 ± 36	2.99 ± 0.00	9.6	2.22
GBU		KUT	0.05910 ± 0.0096	501.2 ± 8.1	3.98 ± 0.00	11.6	1.88
BA	Grand Junction, Colorado	FN	0.02206 ± 0.00032	187.1 ± 2.7	3.99 ± 0.00	7.8	2.22
BB		FN	0.3227 ± 0.0048	2737 ± 41	3.97 ± 0.00	7.9	2.21
BH		TC	1.108 ± 0.032	9399 ± 271	4.00 ± 0.01	8.1	2.22
BL		TC	0.1182 ± 0.0017	1002 ± 14	3.97 ± 0.00	7.8	2.23
BU		KUT	0.0665 ± 0.0011	564.0 ± 9.1	4.01 ± 0.01	11.3	1.91

^a TC indicates primarily intended for use in calibrating total-count logging systems; similarly, FN indicates fission neutron logging systems, and KUT for spectral logging systems.

^b Uncertainties are expressed at the 1-sigma (67 percent confidence) level. Uncertainties reported at 0.00 ft are not zero, but are less than 0.005 ft.

^c No uncertainties have been calculated. Uncertainty is assumed to be less than 10 percent at the 67 percent confidence level.

Reference

George, D.C., B.E. Heistand, and J.E. Krabacher, 1983. *Grade Assignments for Models Used for Calibration of Gross-Count Gamma-Ray Logging Systems*, GJBX-39(83), Bendix Field Engineering Corporation, Grand Junction Operations, Grand Junction, Colorado.

This page intentionally left blank